

DOMODEK®



Metal mutfak aksesuarları kiler, banyo, gardrop ve bar sistemleri
Metal kitchen accessories pantry, bathroom, wardrop and bar systems



COLOR OPTIONS

CHROME
CODE: XXXXX

ANTHRACITE
CODE: XXXXX-A

GEÇİT ÜRÜN KATALOĞU / PRODUCTS CATALOG

ANTHRACITE COLOR IS AVAILABLE. / ANTRASIT RENK SECENEGİ MEVCUTTUR.

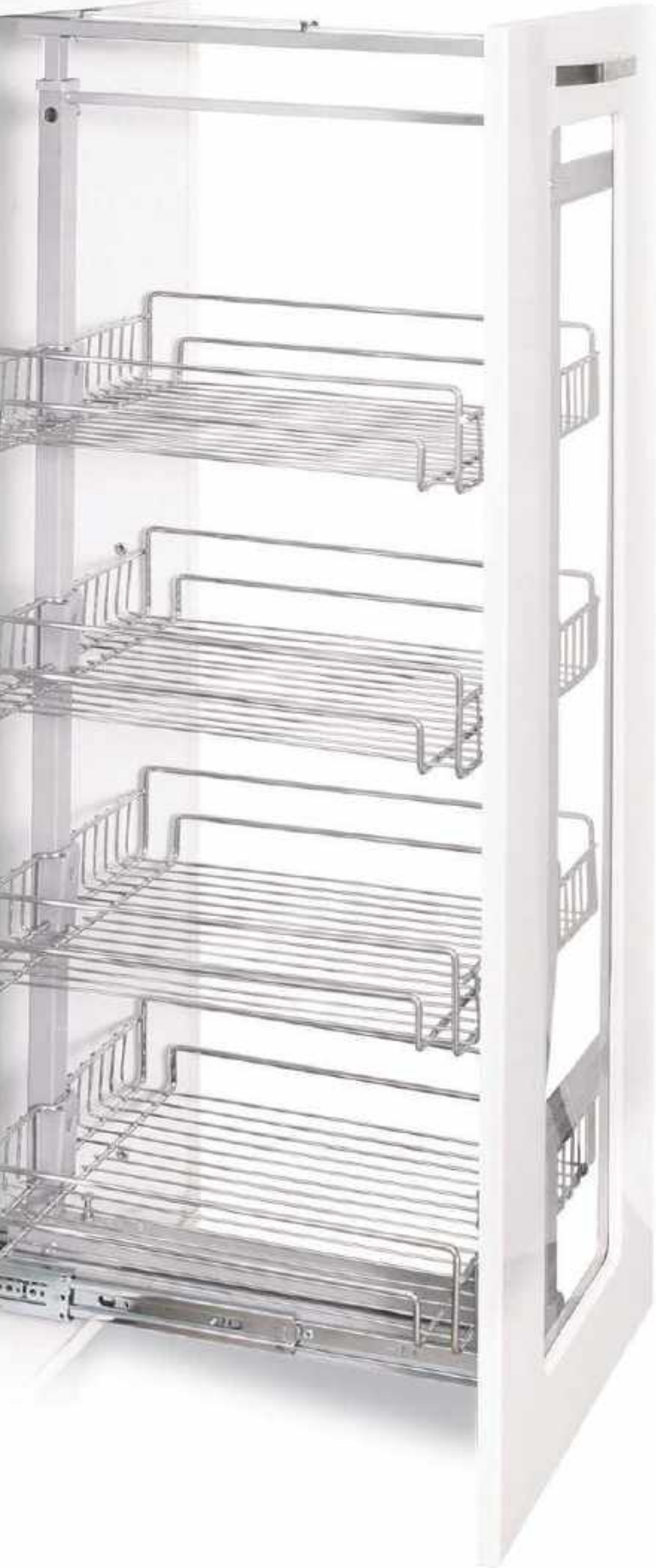

- Alt ve üst mekanizmalarda bilyeli teleskopik ray kullanılmıştır.
- Taşıma kapasitesi sepet başı maksimum 15kg' dır.
- Gövde uzunluğu, modül yüksekliğine uygun ayarlanabilir.
- Sepetler 5 farklı ölçüsü ile modül genişliğine uygundur.
- Alt ve üst mekanizmalar ve gövde gri boyalı, sepetler krom kaplamalıdır.

- Ball bearing telescopic rails are used in the bottom and top mechanisms.
- Carrying capacity is max. 15kg for each basket.
- Body length can be adjusted according to the height of the module.
- Five different size of baskets are appropriate to the width of the module.
- Bottom and top mechanisms and body are painted grey, baskets are chrome plated.



Teleskopik kiler grubu / Telescopic pantry group

Standart Sepet / Standart Basket

COLOR OPTIONS

CHROME
CODE: XXXXX

ANTHRACITE
CODE: XXXXX-A

Ürün Kodu / Product Code	Ürün Adı / Product Name	Sepet / Basket	Ölçüler / Size GxDxY / WxDxH (mm)	Modül / Modul (mm)	Hacim / Volume (m3)	Ağırlık / Weight (kg)
966030	60 - 80 cm	2	230 x 500 x 600 - 800	300	0,07	9,60
966035	60 - 80 cm	2	280 x 500 x 600 - 800	350	0,07	9,99
966040	60 - 80 cm	2	330 x 500 x 600 - 800	400	0,07	10,38
966045	60 - 80 cm	2	380 x 500 x 600 - 800	450	0,07	10,75
966050	60 - 80 cm	2	430 x 500 x 600 - 800	500	0,07	11,11
968530	85 - 110 cm	3	230 x 500 x 850 - 1100	300	0,12	11,08
968535	85 - 110 cm	3	280 x 500 x 850 - 1100	350	0,12	11,60
968540	85 - 110 cm	3	330 x 500 x 850 - 1100	400	0,12	12,14
968545	85 - 110 cm	3	380 x 500 x 850 - 1100	450	0,12	12,70
968550	85 - 110 cm	3	430 x 500 x 850 - 1100	500	0,12	13,23
961130	110 - 125 cm	4	230 x 500 x 1100 - 1250	300	0,13	12,47
961135	110 - 125 cm	4	280 x 500 x 1100 - 1250	350	0,13	13,12
961140	110 - 125 cm	4	330 x 500 x 1100 - 1250	400	0,13	13,80
961145	110 - 125 cm	4	380 x 500 x 1100 - 1250	450	0,13	14,59
961150	110 - 125 cm	4	430 x 500 x 1100 - 1250	500	0,13	15,22
961230	125 - 140 cm	4	230 x 500 x 1250 - 1400	300	0,15	12,80
961235	125 - 140 cm	4	280 x 500 x 1250 - 1400	350	0,15	13,45
961240	125 - 140 cm	4	330 x 500 x 1250 - 1400	400	0,15	14,16
961245	125 - 140 cm	4	380 x 500 x 1250 - 1400	450	0,15	14,92
961250	125 - 140 cm	4	430 x 500 x 1250 - 1400	500	0,15	15,54
961430	140 - 155 cm	5	230 x 500 x 1400 - 1550	300	0,17	14,06
961435	140 - 155 cm	5	280 x 500 x 1400 - 1550	350	0,17	14,85
961440	140 - 155 cm	5	330 x 500 x 1400 - 1550	400	0,17	15,72
961445	140 - 155 cm	5	380 x 500 x 1400 - 1550	450	0,17	16,70
961450	140 - 155 cm	5	430 x 500 x 1400 - 1550	500	0,17	17,46
961530	155 - 170 cm	5	230 x 500 x 1550 - 1700	300	0,18	14,23
961535	155 - 170 cm	5	280 x 500 x 1550 - 1700	350	0,18	15,02
961540	155 - 170 cm	5	330 x 500 x 1550 - 1700	400	0,18	15,86
961545	155 - 170 cm	5	380 x 500 x 1550 - 1700	450	0,18	16,87
961550	155 - 170 cm	5	430 x 500 x 1550 - 1700	500	0,18	17,63
961730	170 - 185 cm	6	230 x 500 x 1700 - 1850	300	0,20	15,95
961735	170 - 185 cm	6	280 x 500 x 1700 - 1850	350	0,20	16,88
961740	170 - 185 cm	6	330 x 500 x 1700 - 1850	400	0,20	17,96
961745	170 - 185 cm	6	380 x 500 x 1700 - 1850	450	0,20	19,22
961750	170 - 185 cm	6	430 x 500 x 1700 - 1850	500	0,20	20,09
961830	185 - 200 cm	6	230 x 500 x 1850 - 2000	300	0,22	16,13
961835	185 - 200 cm	6	280 x 500 x 1850 - 2000	350	0,22	17,06
961840	185 - 200 cm	6	330 x 500 x 1850 - 2000	400	0,22	18,14
961845	185 - 200 cm	6	380 x 500 x 1850 - 2000	450	0,22	19,40
961850	185 - 200 cm	6	430 x 500 x 1850 - 2000	500	0,22	20,27
962030	200 - 215 cm	7	230 x 500 x 2000 - 2150	300	0,23	17,43
962035	200 - 215 cm	7	280 x 500 x 2000 - 2150	350	0,23	18,49
962040	200 - 215 cm	7	330 x 500 x 2000 - 2150	400	0,23	19,73
962045	200 - 215 cm	7	380 x 500 x 2000 - 2150	450	0,23	21,18
962050	200 - 215 cm	7	430 x 500 x 2000 - 2150	500	0,23	22,25

TEK SEPET / SINGLE BASKET

Kiler sistemleri grubu / Pantry units

SSSSS SOFT CLOSE (Frenli)



Frenli kiler grubu / Soft close pantry group

SOFT CLOSE (Frenli)

COLOR OPTIONS

CHROME
CODE: XXXXX

ANTHRACITE
CODE: XXXX-A

Frenli kiler grubu / Soft close pantry units

Standart Sepet / Standard Basket

Ürün Kodu / Product Code	Ürün Adı / Product Name	Sepet / Basket	Ölçüler / Size GxDxY / WxDxH (mm)	Modül / Modul (mm)	Hacim / Volume (m3)	Ağırlık / Weight (kg)
976030	60 - 80 cm	2	230 x 500 x 600 - 800	300	0,07	15,60
976035	60 - 80 cm	2	280 x 500 x 600 - 800	350	0,07	15,99
976040	60 - 80 cm	2	330 x 500 x 600 - 800	400	0,07	16,38
976045	60 - 80 cm	2	380 x 500 x 600 - 800	450	0,07	16,75
976050	60 - 80 cm	2	430 x 500 x 600 - 800	500	0,07	17,11
978530	85 - 110 cm	3	230 x 500 x 850 - 1100	300	0,12	17,08
978535	85 - 110 cm	3	280 x 500 x 850 - 1100	350	0,12	17,60
978540	85 - 110 cm	3	330 x 500 x 850 - 1100	400	0,12	18,14
978545	85 - 110 cm	3	380 x 500 x 850 - 1100	450	0,12	18,70
978550	85 - 110 cm	3	430 x 500 x 850 - 1100	500	0,12	19,23
971130	110 - 125 cm	4	230 x 500 x 1100 - 1250	300	0,13	18,47
971135	110 - 125 cm	4	280 x 500 x 1100 - 1250	350	0,13	19,12
971140	110 - 125 cm	4	330 x 500 x 1100 - 1250	400	0,13	19,80
971145	110 - 125 cm	4	380 x 500 x 1100 - 1250	450	0,13	20,59
971150	110 - 125 cm	4	430 x 500 x 1100 - 1250	500	0,13	21,22
971230	125 - 140 cm	4	230 x 500 x 1250 - 1400	300	0,15	18,80
971235	125 - 140 cm	4	280 x 500 x 1250 - 1400	350	0,15	19,45
971240	125 - 140 cm	4	330 x 500 x 1250 - 1400	400	0,15	20,16
971245	125 - 140 cm	4	380 x 500 x 1250 - 1400	450	0,15	20,92
971250	125 - 140 cm	4	430 x 500 x 1250 - 1400	500	0,15	21,54
971430	140 - 155 cm	5	230 x 500 x 1400 - 1550	300	0,17	20,06
971435	140 - 155 cm	5	280 x 500 x 1400 - 1550	350	0,17	20,85
971440	140 - 155 cm	5	330 x 500 x 1400 - 1550	400	0,17	21,72
971445	140 - 155 cm	5	380 x 500 x 1400 - 1550	450	0,17	22,70
971450	140 - 155 cm	5	430 x 500 x 1400 - 1550	500	0,17	23,46
971530	155 - 170 cm	5	230 x 500 x 1550 - 1700	300	0,18	20,23
971535	155 - 170 cm	5	280 x 500 x 1550 - 1700	350	0,18	21,02
971540	155 - 170 cm	5	330 x 500 x 1550 - 1700	400	0,18	21,88
971545	155 - 170 cm	5	380 x 500 x 1550 - 1700	450	0,18	22,87
971550	155 - 170 cm	5	430 x 500 x 1550 - 1700	500	0,18	23,63
971730	170 - 185 cm	6	230 x 500 x 1700 - 1850	300	0,20	21,95
971735	170 - 185 cm	6	280 x 500 x 1700 - 1850	350	0,20	22,68
971740	170 - 185 cm	6	330 x 500 x 1700 - 1850	400	0,20	23,96
971745	170 - 185 cm	6	380 x 500 x 1700 - 1850	450	0,20	25,22
971750	170 - 185 cm	6	430 x 500 x 1700 - 1850	500	0,20	26,09
971830	185 - 200 cm	6	230 x 500 x 1850 - 2000	300	0,22	22,13
971835	185 - 200 cm	6	280 x 500 x 1850 - 2000	350	0,22	23,06
971840	185 - 200 cm	6	330 x 500 x 1850 - 2000	400	0,22	24,14
971845	185 - 200 cm	6	380 x 500 x 1850 - 2000	450	0,22	25,40
971850	185 - 200 cm	6	430 x 500 x 1850 - 2000	500	0,22	26,27
972030	200 - 215 cm	7	230 x 500 x 2000 - 2150	300	0,23	23,43
972035	200 - 215 cm	7	280 x 500 x 2000 - 2150	350	0,23	24,49
972040	200 - 215 cm	7	330 x 500 x 2000 - 2150	400	0,23	25,73
972045	200 - 215 cm	7	380 x 500 x 2000 - 2150	450	0,23	27,18
972050	200 - 215 cm	7	430 x 500 x 2000 - 2150	500	0,23	28,25

TEK SEPET / SINGLE BASKET

2 years
guarantee

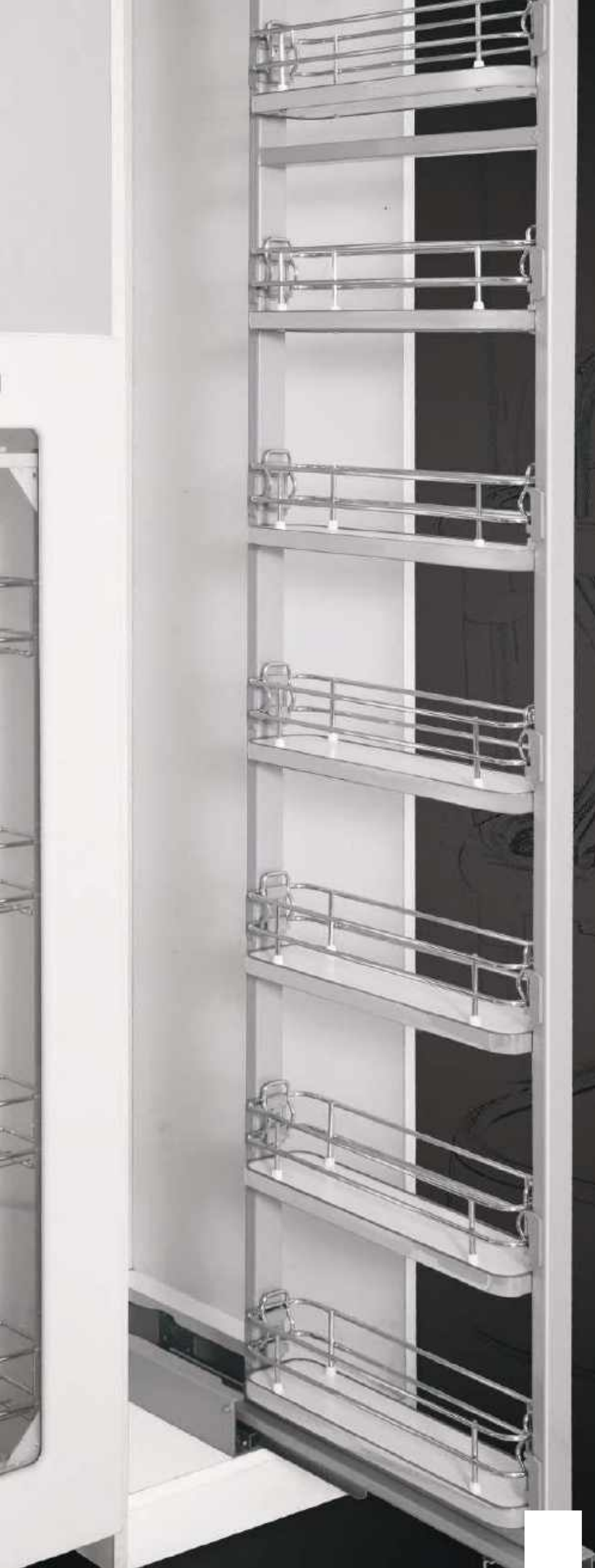

Ahşap tabanlı lüks frenli kiler grubu / Wooden based lux soft close pantry group



- Sepet tabanları 18mm MDFLAM' dır.
- Taşıma kapasitesi maksimum 50 kg' dır.
- Gövde uzunluğu, kabin yüksekliğine uygun olarak ayarlanabilir.
- Sepetler 7 farklı ölçüsü ile istediğiniz modül genişliğine uygundur.
- İster menteşeli kapakla ister ürüne monte kapakla kullanılabilir

- *Basket floors are made of 18mm MDF.*
- *Carrying capacity is 50 kg.*
- *Height of the body can be adjusted according to the height of the cabinet.*
- *Sevendifferent size of baskets are appropriate to the width of the modüle.*
- *Available hinged cabinets with door or mounted module covers.*



COLOR OPTIONS

CHROME
CODE: XXXXX

ANTHRACITE
CODE: XXXXX-A

Ahşap tabanlı lüks frenli kiler grubu / Wooden based lux soft close pantry group

Ürün Kodu / Product Code	Sepet / Basket	Ölçüler / Size GxDxY / WxDxH (mm)	Modül / Modul (mm)	Hacim / Volume (m3)	Ağırlık / Weight (kg)
92916	2	150 x 500 x 700 - 850	200	0,09	12,00
92917	2	200 x 500 x 700 - 850	250	0,09	12,50
92911	2	250 x 500 x 700 - 850	300	0,09	12,90
92912	2	300 x 500 x 700 - 850	350	0,09	13,50
92913	2	350 x 500 x 700 - 850	400	0,09	14,10
92914	2	400 x 500 x 700 - 850	450	0,09	14,70
92915	2	450 x 500 x 700 - 850	500	0,09	15,30
92926	3	150 x 500 x 850 - 1100	200	0,12	14,50
92927	3	200 x 500 x 850 - 1100	250	0,12	15,30
92921	3	250 x 500 x 850 - 1100	300	0,12	15,80
92922	3	300 x 500 x 850 - 1100	350	0,12	16,40
92923	3	350 x 500 x 850 - 1100	400	0,12	17,00
92924	3	400 x 500 x 850 - 1100	450	0,12	17,60
92925	3	450 x 500 x 850 - 1100	500	0,12	18,20
92936	4	150 x 500 x 1250 - 1400	200	0,14	19,00
92937	4	200 x 500 x 1250 - 1400	250	0,14	19,50
92931	4	250 x 500 x 1250 - 1400	300	0,14	20,00
92932	4	300 x 500 x 1250 - 1400	350	0,14	20,60
92933	4	350 x 500 x 1250 - 1400	400	0,14	21,20
92934	4	400 x 500 x 1250 - 1400	450	0,14	21,80
92935	4	450 x 500 x 1250 - 1400	500	0,14	22,40
92946	5	150 x 500 x 1550 - 1700	200	0,17	23,00
92947	5	200 x 500 x 1550 - 1700	250	0,17	23,50
92941	5	250 x 500 x 1550 - 1700	300	0,17	23,90
92942	5	300 x 500 x 1550 - 1700	350	0,17	24,50
92943	5	350 x 500 x 1550 - 1700	400	0,17	25,10
92944	5	400 x 500 x 1550 - 1700	450	0,17	25,70
92945	5	450 x 500 x 1550 - 1700	500	0,17	26,30
92956	6	150 x 500 x 1850 - 2000	200	0,21	33,00
92957	6	200 x 500 x 1850 - 2000	250	0,21	33,80
92951	6	250 x 500 x 1850 - 2000	300	0,21	34,2
92952	6	300 x 500 x 1850 - 2000	350	0,21	36,5
92953	6	350 x 500 x 1850 - 2000	400	0,21	38,5
92954	6	400 x 500 x 1850 - 2000	450	0,21	40,5
92955	6	450 x 500 x 1850 - 2000	500	0,21	42,5
92966	7	150 x 500 x 2000 - 2150	200	0,25	45,50
92967	7	200 x 500 x 2000 - 2150	250	0,25	46,00
92961	7	250 x 500 x 2000 - 2150	300	0,25	46,5
92962	7	300 x 500 x 2000 - 2150	350	0,25	48,5
92963	7	350 x 500 x 2000 - 2150	400	0,25	50,5
92964	7	400 x 500 x 2000 - 2150	450	0,25	52,5
92965	7	450 x 500 x 2000 - 2150	500	0,25	54,5

2 years
guarantee



Alüminyum kiler grubu / Aluminium soft close pantry group

- Alt mekanizmadaki üstün tasarım, montajda kolaylık ve zaman tasarrufu sağlar.
- Alt mekanizmadaki raylar ve yan destek rayı yavaş ve sessiz otomatik kapanış sağlar.
- Taşıma kapasitesi maksimum 50 kg' dır.
- Kabin tavan bağlantısı olmadığından kabin yüksekliğinde esneklik sağlar.
- 4 kata kadar yükseklik ve 5 genişlik ölçülü sepet seçenekleriyle herkese ve her mutfağa hitap eder.
- Rijit gövdesi ile uzun ömürlü kullanıma uygundur.
- Eloksal kaplıdır. Paslanmaz.
- Sepet tabanları 8mm MDFLAM' dir.

- Excellent design of the bottom mechanism provides you an easy assembly and time saving.
- Rails at the bottom mechanism and at the side of the body provides silent and smooth closing.
- Carrying capacity is 50 kg.
- There is no top mechanism. So the space over the body is flexible.
- Four different height with 5 different basket sizes are appropriate to the width of the modüle.
- Aluminium pantries has long life with their rigid bodies.
- Surfaces are Anodising plated.
- Basket floors are made of 8mm MDF.

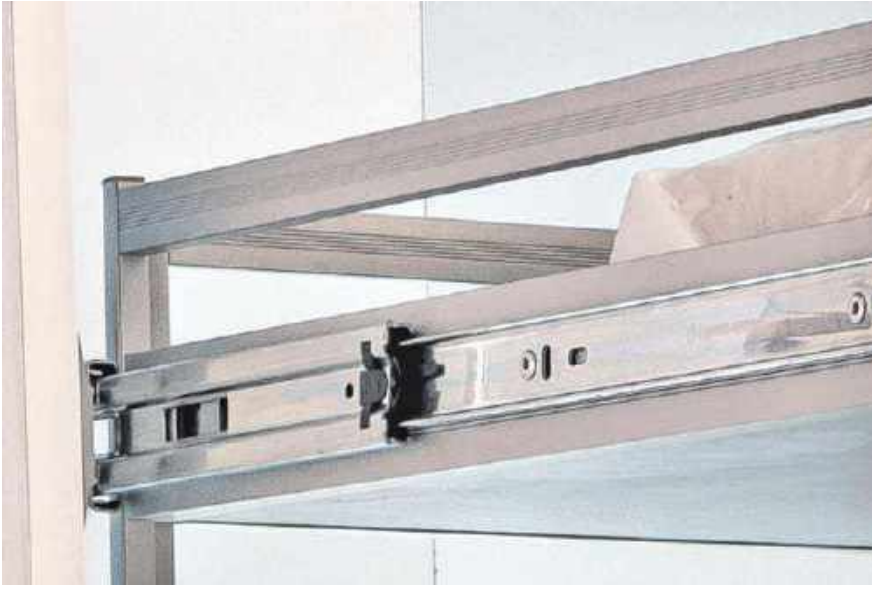

SOFT CLOSE (Frenli)

Alüminyum kiler grubu / Aluminium soft close pantry group

Ürün Kodu / Product Code	Sepet / Basket	Ölçüler / Size GxDxY / WxDxH (mm)	Modül / Modul (mm)	Hacim / Volume (m3)	Ağırlık / Weight (kg)
91811	2	264 x 503 x 465	300	0,06	8,00
91812	2	314 x 503 x 465	350	0,07	8,50
91813	2	364 x 503 x 465	400	0,09	9,00
91814	2	414 x 503 x 465	450	0,10	9,50
91815	2	464 x 503 x 465	500	0,11	10,00
91821	3	264 x 503 x 760	300	0,10	9,75
91822	3	314 x 503 x 760	350	0,12	10,35
91823	3	364 x 503 x 760	400	0,14	10,95
91824	3	414 x 503 x 760	450	0,16	11,55
91825	3	464 x 503 x 760	500	0,18	12,15
91831	4	264 x 503 x 1055	300	0,14	11,70
91832	4	314 x 503 x 1055	350	0,17	12,55
91833	4	364 x 503 x 1055	400	0,19	13,40
91834	4	414 x 503 x 1055	450	0,22	14,25
91835	4	464 x 503 x 1055	500	0,25	15,10
91841	5	264 x 503 x 1350	300	0,18	13,50
91842	5	314 x 503 x 1350	350	0,21	14,60
91843	5	364 x 503 x 1350	400	0,25	15,70
91844	5	414 x 503 x 1350	450	0,28	16,80
91845	5	464 x 503 x 1350	500	0,32	17,90

2 years
guarantee



İKiz kiler grubu / Twince pantry units

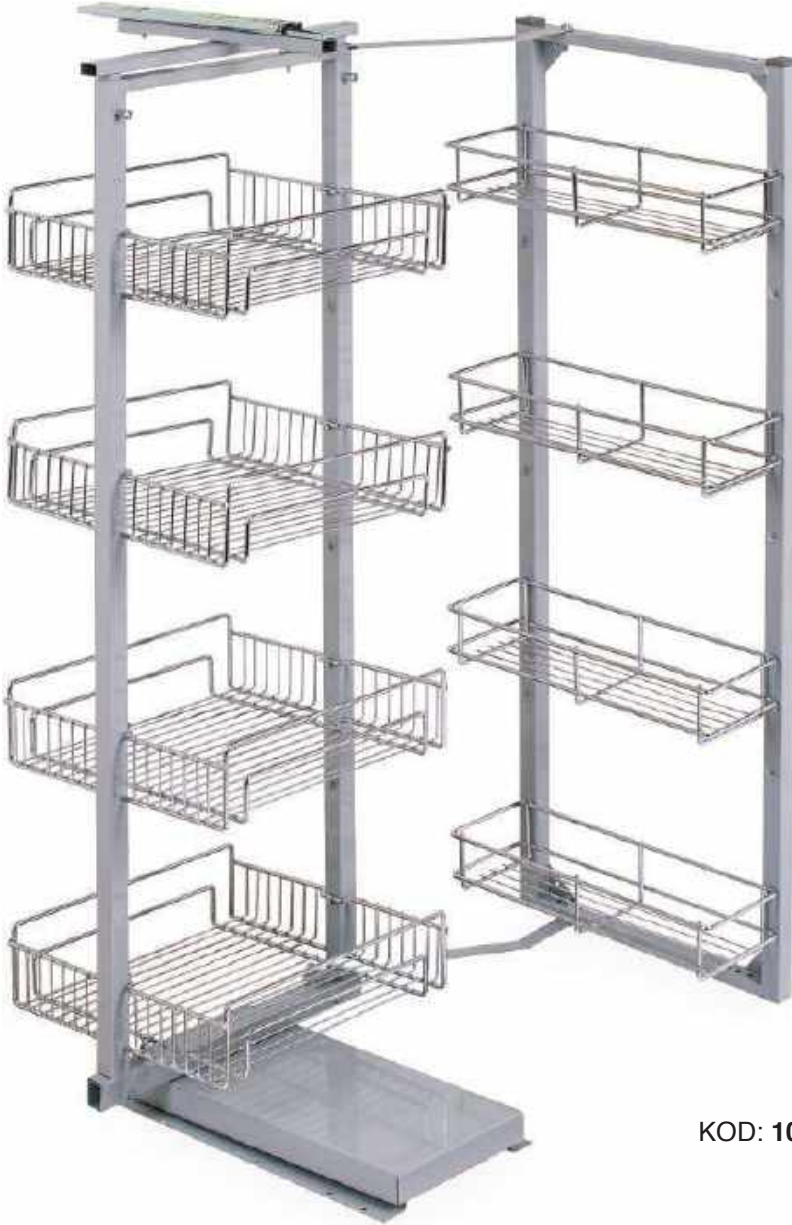

KOD: 10205

COLOR OPTIONS

CHROME
CODE: XXXXX

ANTHRACITE
CODE: XXXXX-A

Bergama ikiz kiler / Bergamon twince pantry

Ürün Kodu / Product Code	Tip / Type	Ölçüler / Size GxDxY / WxDxH (mm)	Modül / Modul (mm)	Hacim / Volume (m3)	Ağırlık / Weight (kg)
10105	125'lik	500 x 500 x 1250 - 1400	60	0,24	20,00
10205	125'lik	350 x 500 x 1250 - 1400	45	0,24	17,80
10116	170'lik	500 x 500 x 1700 - 1850	60	0,30	30,00
10114	170'lik	350 x 500 x 1700 - 1850	45	0,30	25,00

TSEK

DOMODEK®

2 years
guarantee



KOD: 91167

Alüminyum lüks ikiz kiler grubu / Aluminium lux twince pantry units



KOD: 91166

- Alt mekanizmadaki üstün tasarım, montajda kolaylık ve zaman tasarrufu sağlar.
- Alt mekanizmadaki raylar ve yan destek rayı yavaş ve sessiz otomatik kapanış sağlar.
- Taşıma kapasitesi maksimum 50 kg' dır.
- Kabin tavan bağlantısı olmadığından kabin yüksekliğinde esneklik sağlar.
- Rijit gövdesi ile uzun ömürlü kullanıma uygundur.
- Eloksoal kaplıdır. Paslanmaz.
- Sepet tabanları 8mm MDFLAM' dır.
- *Excellent design of the bottom mechanism provides you an easy assembly and time saving.*
- *Rails at the bottom mechanism and at the side of the body provides silent and smooth closing.*
- *Carrying capacity is 50 kg.*
- *There is no top mechanism. So the space over the body is flexible.*
- *Aluminium pantries has long life with their rigid bodies.*
- *Surfaces are Anodising plated.*
- *Basket floors are made of 8mm MDF.*

SOFT CLOSE (Frenli)



Alüminyum lüks ikiz kiler / Aluminium lux twince pantry

Ürün Kodu / Product Code	Tip / Type	Ölçüler / Size GxDxY / WxDxH (mm)	Modül / Modul (mm)	Hacim / Volume (m3)	Ağırlık / Weight (kg)
91105	tezgah altı / under counter	452 x 515 x 465	50	0,11	10,00
91107	tezgah altı / under counter	552 x 515 x 465	60	0,13	11,00
91166	110'luk	452 x 515 x 1055	50	0,25	16,00
91167	110'luk	552 x 515 x 1055	60	0,30	18,60

TSEK

DOMODEK®

2 years
guarantee



KOD: 39191

Kör köşe grubu / Secret corner group



- Mutfaklarınızdaki köşe bölgeleri değerlendirmek içindir.
- Menteşeli kapak ile kullanıma uygundur.
- Taşıma kapasitesi, her bir sepet için 20kg' dir.
- Taşıyıcı boru, dolap yüksekliğine uygun ayarlanabilir.
- Sepetler birbirinden bağımsızdır çıkarılabilir.
- Sepet tabanları 18mm MDFLAM' dir.
- Sepet çevresi krom kaplama görünümlüdür.
- Sepet çerçevesi krom kaplamadır.
- Mekanizmalar gri renkte, sepet tabanları beyaz renktedir.

- Can be used to reach corner regions in your kitchen.
- Available hinged door on the corner cabinets.
- Carrying capacity is 20 kg for each basket.
- Carrier pipe can be adjusted according to the cabinet height.
- Both baskets are independent to each other.
- Basket floors are made of 18mm MDF.
- Baskets are surrounded by material looks like chrome plated.
- Basket frames are chrome plated.
- Mechanisms are grey, basket floors are white.

KOD: 39193 / Sol

Ahşap tabanlı elips kör köşe grubu / Wooden secret corner group

Ürün Kodu / Product Code	Model / Model	Modül / Modul (mm)	Ölçüler / Size GxDxY / WxDxH (mm)	Hacim / Volume (m3)	Ağırlık / Weight (kg)
39192 (frenli&Soft Close)	elips sağ / elips (right)	45	900 x 530 x 750	0,08	13,00
39193 (frenli&Soft Close)	elips sol / elips (left)	45	900 x 530 x 750	0,08	13,00
39392 (frenli&Soft Close) (ANTRASİT)	elips sağ / elips (right)	45	900 x 530 x 750	0,08	13,00
39393 (frenli&Soft Close) (ANTRASİT)	elips sol / elips (left)	45	900 x 530 x 750	0,08	13,00



COLOR OPTIONS

CHROME
CODE: XXXXX

ANTHRACITE
CODE: XXXXX-A

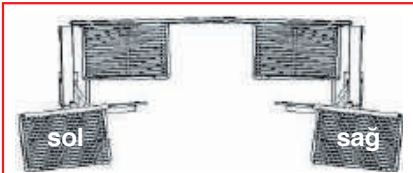

Kapağa Monte Edilir.
Cover Tied Pantry.

Kapak ölçüsü minimum 38 cm olmalıdır.
Minimum cabinet door size is 38cm.

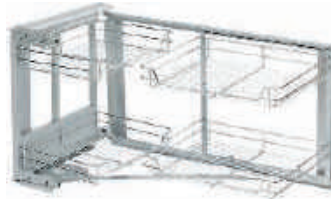

KOD: 39196

- Taşıma kapasitesi kapak mekanizması için 15 kg, arka mekanizma için 20 kg dir.
- Sepetler istenen aralıklarla asılarak kullanılır.
- Modül kapağının açılmasıyla ön taşıyıcıdaki sepetler dışarı çıkar, aynı anda arka taşıyıcı üzerindeki sepetler hareket ederek kolay ulaşılabilir pozisyonu alır.

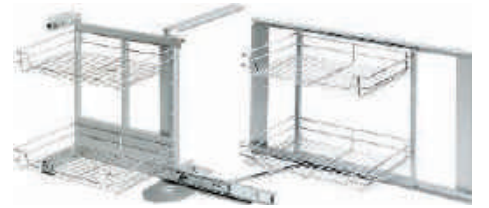

SOFT CLOSE (Frenli)

- Carrying capacity for door mechanism is 20 kg, for back mechanism 30 kg.
- Baskets can be installed with desired distances.
- When you open module door; baskets on the front carrier come out at the same time baskets on the behind carrier move and have easily accessible position.

Kapağa monte kör köşe grubu / Secret corner group

Ürün Kodu / Product Code	Model / Model	Modül / Modul (mm)	Ölçüler / Size GxDxY / WxDxH (mm)	Hacim / Volume (m3)	Ağırlık / Weight (kg)
39195	sağ / (right) frenli/soft close	40	860 x 530 x 600	0,15	20,20
39196	sol / (left) frenli/soft close	40	860 x 530 x 600	0,15	20,20

2 years
guarantee



KOD: 23068

Döner köşe grubu / Revolving corner group

- Menteşeli iki kapak ile kullanıma uygundur.
 - Taşıma kapasitesi, her sepet için 20 kg dır.
 - Alt sepet, taşıyıcı boru üzerinde tabanda, üst sepet ortada sabitlenerek kullanılır.
 - Taşıyıcı boru üzerinde 360° döndürülen sepetlerin her noktasına ulaşabilmek mümkündür.
 - Taşıyıcı boru, dolap yüksekliğine uygun ayarlanabilir.
 - Mekanizmada sepetler krom kaplamalı, taşıyıcı boru alüminyumdur.
- Available hinged two doors on the corner cabinets.
 - Carrying capacity is 20 kg for each of basket.
 - Bottom basket can be fixed on the carrier pipe at the base, upper basket can be fixed in the middle of the pipe.
 - Possible to reach any point of 3600 turning baskets on the carrier pipe.
 - Carrier pipe can be adjusted according to the cabinet height.
 - Baskets are chrome plated, carrier pipe is aluminum.

SOFT STOP
FRENLİ

COLOR OPTIONS

CHROME
CODE: XXXXX

ANTHRACITE
CODE: XXXXX-A

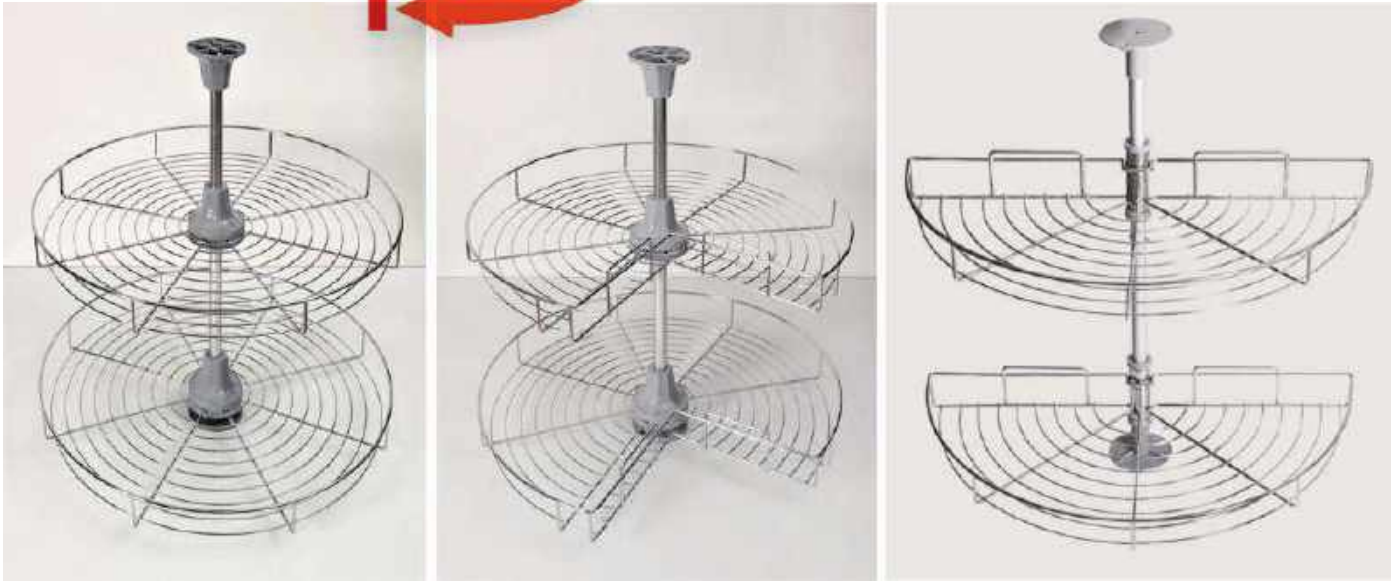

KOD: 24069

KOD: 23068

KOD: 22099

Döner köşe grubu / Revolving corner group

Ürün Kodu / Product Code	Model / Model	Ölçüler / Size GxDxY / WxDxH (mm)	Hacim / Volume (m3)	Ağırlık / Weight (kg)
24067	4/4 56	560 x 560 x 700 - 750	0,07	5,30
24069	4/4 72	720 x 720 x 700 - 750	0,11	6,30
24203	4/4 82	820 x 820 x 700 - 750	0,15	7,20
23066	3/4 56	560 x 560 x 700 - 750	0,07	5,00
23068	3/4 72	720 x 720 x 700 - 750	0,11	6,00
23201	3/4 82	820 x 820 x 700 - 750	0,15	7,00
22100	1/2 64 (borulu/with tube)	640 x 320 x 700 - 750	0,07	4,50
22099	1/2 74 (borulu/with tube)	740 x 370 x 700 - 750	0,07	5,20

TSEK

DOMODEK®



Mutfađınız için iyi bir fikrimiz var
We have a good idea for your kitchen

Ahşap tabanlı döner köşe grubu / Wooden based revolving corner group

- Mutfaklarınızdaki köşe bölgeleri değerlendirmek içindir.
- Menteşeli kapak ile kullanıma uygundur.
- Taşıma kapasitesi, her bir sepet için 20kg' dır.
- Taşıyıcı boru, dolap yüksekliğine uygun ayarlanabilir.
- Sepetler birbirinden bağımsızdır çıkarılabilir.
- Sepet tabanları 18mm MDFLAM' dır.
- Sepet çevresi krom kaplama görünümlüdür.
- Sepet çerçevesi krom kaplamadır.
- Mekanizmalar gri renkte, sepet tabanları beyaz renktedir.

- Can be used to reach corner regions in your kitchen.
- Available hinged door on the corner cabinets.
- Carrying capacity is 20 kg for each basket.
- Carrier pipe can be adjusted according to the cabinet height.
- Both baskets are independent to each other.
- Basket floors are made of 18mm MDF.
- Baskets are surrounded by material looks like chrome plated.
- Basket frames are chrome plated.
- Mechanisms are grey, basket floors are white.

COLOR OPTIONS

CHROME
CODE: XXXXX

ANTHRACITE
CODE: XXXXX-A



KOD: 24962



KOD: 23962



KOD: 22951

Ahşap Tabanlı Döner köşe grubu / Wooden based revolving corner group

Ürün Kodu / Product Code	Model / Model	Ölçüler / Size GxDxY / WxDxH (mm)	Hacim / Volume (m3)	Ağırlık / Weight (kg)
24961	4/4 56	560 x 560 x 700 - 750	0,07	12,70
24962	4/4 72	720 x 720 x 700 - 750	0,12	14,90
23961	3/4 56	560 x 560 x 700 - 750	0,07	11,20
23962	3/4 72	720 x 720 x 700 - 750	0,12	13,20
22950	1/2 64	640 x 320 x 700 - 750	0,07	7,50
22951	1/2 74	740 x 320 x 700 - 750	0,07	9,00

Yandan raylı şişelik-deterjanlık grubu / Bottle-detergent unit side tied



KOD: 30132

- Tezgah altında, menteşeli kapaklı dolaplarda ya da modül kapağına monte edilerek kullanılır.
- Genişliği dar modüllerde maksimum kullanım alanı sağlar.
- Taşıma kapasitesi 15 kg dır.
- İster bilyalı teleskobik rayla ister yavaş ve sessiz kapanma sağlayan soft close teleskobik rayla kullanılabilir.
- Modülün sağ veya sol paneline monte edilebilir.
- Sepet yüzeyleri krom kaplamadır.



KOD: 31133

- Available under-counter hinged cabinets with door or mounted module covers.
- Narrow width of the module provides the maximum use of space.
- Carrying capacity 15 kg.
- Can be used with ball bearing telescopic rails or soft close telescopic rails which provides silent and smooth closing.
- Baskets are chrome plated.

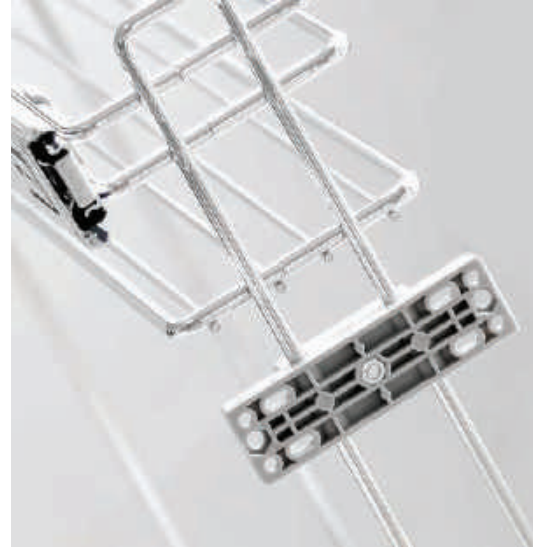

KOD:31133



COLOR OPTIONS

CHROME
CODE: XXXXX

ANTHRACITE
CODE: XXXXX-A

Yandan raylı şişelik-deterjanlık grubu / Bottle-detergent unit side tied

Ürün Kodu / Product Code	Tip / Type	Ölçüler / Size GxDxY / WxDxH (mm)	Modül / Modul (mm)	Hacim / Volume (m3)	Koli içi Ad. / Volume (m3)	Ağırlık / Weight (kg)
30132	Teleskopik Telescopic	Şişelik / bottle holder	15	0,03	5	4,20
31133		Deterjanlık / detergent place	20	0,04	4	4,50
31135			25	0,06	1	4,80
32134		Dar-geniş / tight-wide	30	0,06	1	5,20
32504		Geniş-geniş / wide-wide	30	0,06	1	5,50
30111	Frenli Soft close	Şişelik / bottle holder	15	0,03	5	4,20
30112		Deterjanlık / detergent place	20	0,04	4	4,50
30115			25	0,06	1	4,80
30113		Frenli / Soft close - Dar-geniş / tight-wide	30	0,06	1	5,20
30114		Frenli / Soft close - Geniş-geniş / wide-wide	30	0,06	1	5,50
31232	Teleskopik Telescopic	Ekonomik / Economic	15	0,04	5	2,60
31234		Ekonomik / Economic	20	0,05	4	2,90
31235		Ekonomik / Economic	25	0,05	1	3,10
31236		Ekonomik / Economic	30	0,06	1	3,20

TSEK

DOMODEK®

Smart slide deterjanlık grubu / Smart slide detergent unit



SOFT CLOSE (Frenli)

Tandem Ray & Tandem Slides

COLOR OPTIONS

CHROME
CODE: XXXXX

ANTHRACITE
CODE: XXXXX-A

- Tezgah altında, menteşeli kapaklı dolaplarda ya da modül kapağına monte edilerek kullanılır.
- Genişliği dar modüllerde maksimum kullanım alanı sağlar.
- Taşıma kapasitesi 15 kg'dır.
- Smart slide teleskobik raylar kullanılmıştır.
- Modülün sağ veya sol paneline monte edilebilir.
- Sepet yüzeyleri krom kaplamadır.

- Available under-counter hinged cabinets with door or mounted module covers.
- Narrow width of the module provides the maximum use of space.
- Carrying capacity 15 kg.
- Smart slide telescopic rails are used.
- Baskets are chrome plated.

Tandem raylı frenli deterjanlık grubu / Tandem soft close detergent unit group

Ürün Kodu / Product Code	Tip / Type	Ölçüler / Size GxDxY / WxDxH (mm)	Modül / Modul (mm)	Hacim / Volume (m3)	Ağırlık / Weight (kg)
31121	çift açılım frenli / full ex.soft close	108 x 500 x 470	150	0,04	4,80
31122	çift açılım frenli / full ex.soft close	136 x 500 x 470	200	0,05	5,00
31123	çift açılım frenli / full ex.soft close	192 x 500 x 470	250	0,06	5,40
31124	çift açılım frenli / full ex.soft close	256 x 500 x 470	300	0,07	5,70
31127	tek açılım frenli / single ex.soft close	106 x 500 x 470	150	0,04	4,20
31128	tek açılım frenli / single ex.soft close	136 x 500 x 470	200	0,05	4,40
31129	tek açılım frenli / single ex.soft close	192 x 500 x 470	250	0,06	4,80
31130	tek açılım frenli / single ex.soft close	256 x 500 x 470	300	0,07	5,10

Ahşap tabanlı frenli deterjanlık grubu / Wooden based soft close detergent unit group

Ahşap tabanlı teleskobik raylı deterjanlık grubu / Wooden based telescopic rails detergent unit

36121	frenli / soft close	116 x 515 x 475	150	0,04	4,60
36122	frenli / soft close	140 x 515 x 475	200	0,05	5,00
36123	frenli / soft close	206 x 515 x 475	300	0,06	5,50

Altan raylı deterjanlık grubu / Detergent unit

2 years
guarantee



KOD: 33113



KOD: 33111



KOD: 35541

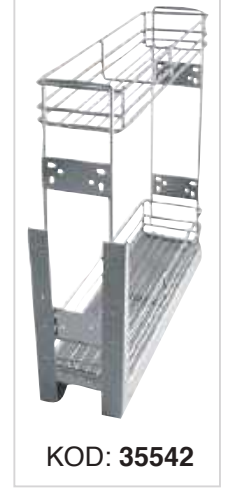

KOD: 35542

Altan raylı şişelik-deterjanlık grubu / Bottom tied bottle-detergent unit

Ürün Kodu / Product Code	Tip / Type	Ölçüler / Size GxDxY / WxDxH (mm)	Modül / Modul (mm)	Hacim / Volume (m3)	Ağırlık / Weight (kg)	
33111	Frenli Soft close	Şişelik / bottle holder	15	0,04	5,20	
33112		Deterjanlık / detergent place	20	0,05	5,50	
33113		Frenli / soft close - Dar-geniş / tight-wide	210 x 520 x 520	30	0,06	5,80
33114		Frenli / soft close - Geniş-geniş / wide-wide	210 x 520 x 520	35	0,06	6,40

COLOR OPTIONS

CHROME
CODE: XXXXX

ANTHRACITE
CODE: XXXXX-A

Bayraklı şişelik-deterjanlık grubu / Oriflame deterjan dacker

Ürün Kodu / Product Code	Tip / Type	Ölçüler / Size GxDxY / WxDxH (mm)	Modül / Modul (mm)	Hacim / Volume (m3)	Ağırlık / Weight (kg)	
35541	Frenli Soft close	Şişelik / botle holder	15	0,04	5,40	
35542			20	0,05	5,70	
35543		Deterjanlık / detergent place	255 x 515 x 540	30	0,06	6,00
35544			315 x 515 x 540	35	0,06	6,60

TSEK

DOMODEK®

2 years
guarantee



SOFT CLOSE

KOD: 91315

Alüminyum yandan raylı şişelik-deterjanlık / Aluminium bottle-detergent unit side tied soft closing



KOD: 91311



KOD: 91313

- Tezgahaltında ister menteşeli kapakla ister ürüne monte kapakla kullanılabilir.
- Kullanılan raylar yavaş ve sessiz otomatik kapanış sağlar.
- 3 farklı modül genişliğine uygun ölçüler mevcuttur.
- Eloksal kaplıdır. Paslanmaz.
- Sepet tabanı 8mm MDFLAM' dir.
- Ürün çerçeve ve sepet gri renktedir.

- Available both hinged cabinets with door and door fasteners to the module.
- Rails provide silent and smooth closing.
- There are three module options.
- Surfaces are Anodising plated.
- Basket floors are made of 8mm MDF.
- Body and the basket floors are gray.

SOFT CLOSE (Frenli)



KOD: 91315



KOD: 91312



KOD: 91314

Alüminyum yandan raylı şişelik-deterjanlık grubu / Aluminium bottle-detergent unit side tied soft closing

Ürün Kodu / Product Code	Yön / Direction	Ölçüler / Size GxDxY / WxDxH (mm)	Modül / Modul (mm)	Hacim / Volume (m3)	Ağırlık / Weight (kg)
91311	sağ / right	113 x 503 x 470	15	0,03	4,30
91312	sol / left	113 x 503 x 470	15	0,03	4,30
91313	sağ / right	163 x 503 x 470	20	0,04	4,75
91314	sol / left	163 x 503 x 470	20	0,04	4,75
91315	sağ / right	213 x 503 x 470	25	0,05	5,20
91316	sol / left	213 x 503 x 470	25	0,05	5,20

2 years
guarantee



Çekmece grubu / Drawer group

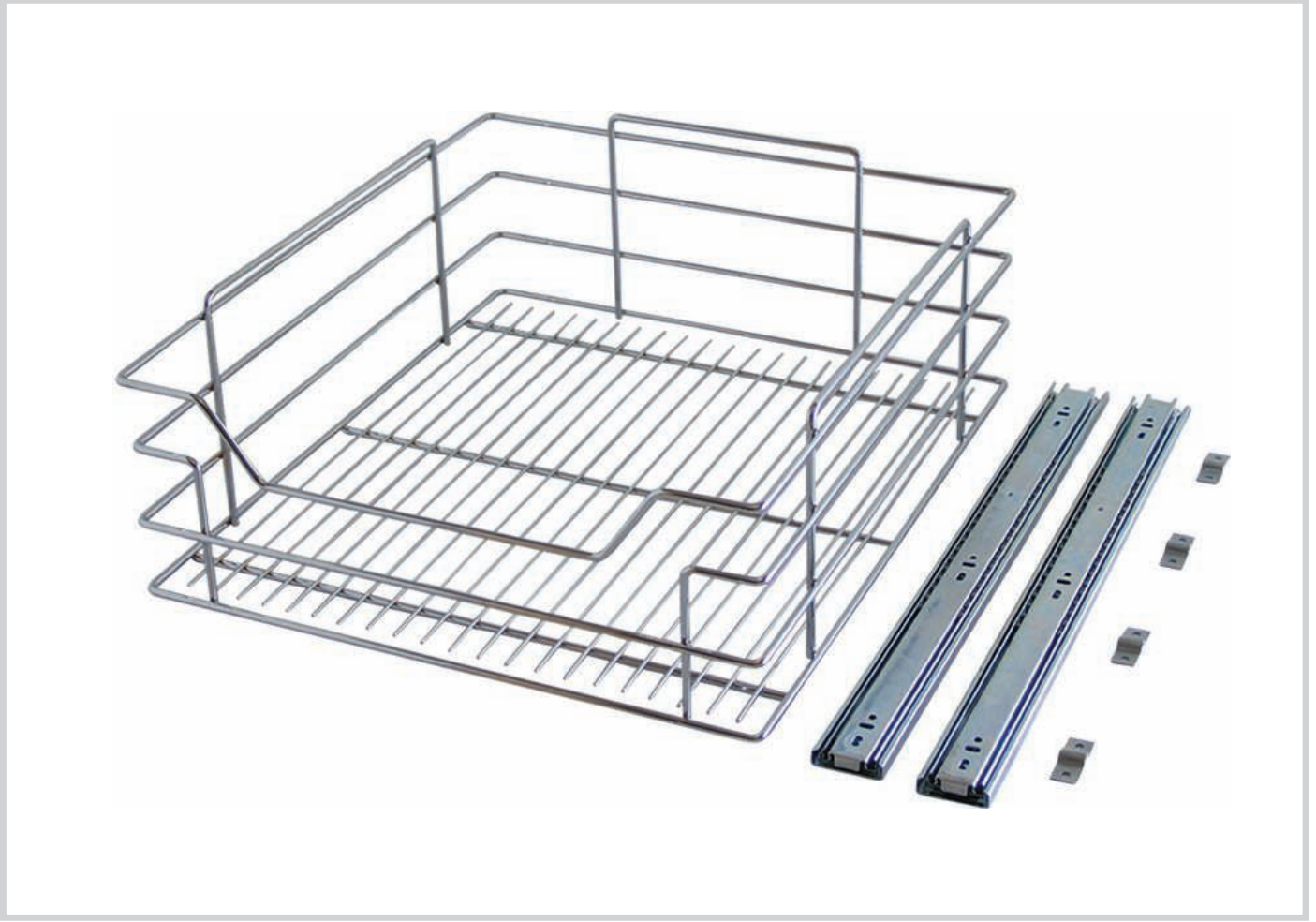

KOD: 63262

- Carrying capacity 15 kg.
- Can be used with ball bearing telescopic rails or soft close telescopic rails which provides silent and smooth closing.
- Baskets with 9 different module sizes are chrome plated.

COLOR OPTIONS

CHROME
CODE: XXXXX

ANTHRACITE
CODE: XXXXX-A

Teleskopik raylı derin çekmece grubu / Telescopic deep drawer group

Ürün Kodu / Product Code	Tip / Type	Ölçüler / Size GxDxY / WxDxH (mm)	Modül / Modul (mm)	Hacim / Volume (m3)	Ağırlık / Weight (kg)
63260	teleskopik / telescopic	300 x 500 x 180	35	0,04	4,70
63261	teleskopik / telescopic	350 x 500 x 180	40	0,04	5,00
63262	teleskopik / telescopic	400 x 500 x 180	45	0,04	5,30
63263	teleskopik / telescopic	450 x 500 x 180	50	0,05	5,60
63264	teleskopik / telescopic	500 x 500 x 180	55	0,06	5,90
63265	teleskopik / telescopic	550 x 500 x 180	60	0,06	6,20
63285	frenli / soft close	300 x 500 x 180	35	0,04	4,70
63286	frenli / soft close	350 x 500 x 180	40	0,04	5,00
63287	frenli / soft close	400 x 500 x 180	45	0,04	5,30
63288	frenli / soft close	450 x 500 x 180	50	0,05	5,60
63289	frenli / soft close	500 x 500 x 180	55	0,06	5,90
63290	frenli / soft close	550 x 500 x 180	60	0,06	6,20

TSEK

DOMODEK®

Tandem raylı çekmece grubu / Tandem slides drawer group



COLOR OPTIONS

CHROME
CODE: XXXXX

ANTHRACITE
CODE: XXXXX-A

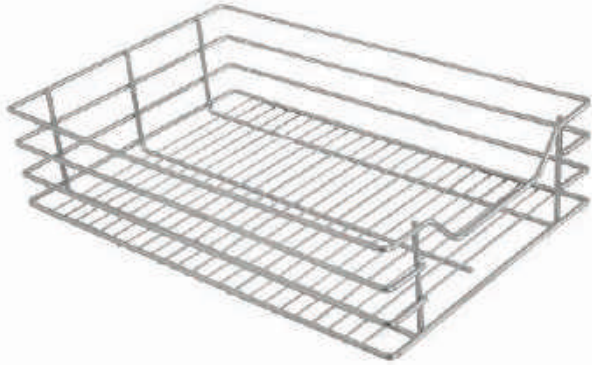

- Tezgah altında, menteşeli kapaklı dolaplarda ya da modül kapağına monte edilerek kullanılır.
- Taşıma kapasitesi 15 kg dır.
- Standart, tek açılım ya da çift açılım tandem raylarla kullanılabilir.
- 6 farklı modül genişliğine uygun sepetler krom kaplamalıdır.

- Available under-counter hinged cabinets with door or mounted module covers.
- Carrying capacity 15 kg.
- Can be used with standart, single-extension soft close or full-extension soft close tandem rails.
- Baskets with 6 different module sizes are chrome plated.

Tandem raylı çekmece grubu / Tandem drawer group

Ürün Kodu / Product Code	Tip / Type	Ölçüler / Size GxDxY / WxDxH (mm)	Modül / Modul (mm)	Hacim / Volume (m3)	Ağırlık / Weight (kg)
64403	çift aç.frenli / full extension.soft close	300 x 500 x 150	35	0,04	5,00
64404	çift aç.frenli / full extension.soft close	350 x 500 x 150	40	0,04	5,30
64405	çift aç.frenli / full extension.soft close	400 x 500 x 150	45	0,04	5,60
64406	çift aç.frenli / full extension.soft close	450 x 500 x 150	50	0,05	5,90
64407	çift aç.frenli / full extension.soft close	500 x 500 x 150	55	0,06	6,20
64408	çift aç.frenli / full extension.soft close	550 x 500 x 150	60	0,06	6,50
64423	tek aç.frenli / single extension.soft close	300 x 500 x 150	35	0,04	5,00
64424	tek aç.frenli / single extension.soft close	350 x 500 x 150	40	0,04	5,30
64425	tek aç.frenli / single extension.soft close	400 x 500 x 150	45	0,04	5,60
64426	tek aç.frenli / single extension.soft close	450 x 500 x 150	50	0,05	5,90
64427	tek aç.frenli / single extension.soft close	500 x 500 x 150	55	0,06	6,20
64428	tek aç.frenli / single extension.soft close	550 x 500 x 150	60	0,06	6,50

Eviye altı çekmece grubu / Sink drawer group



- Tezgah altında, menteşeli kapaklı dolaplarda ya da modül kapağına monte edilerek kullanılır.
- Taşıma kapasitesi 15 kg dır.
- Standart, tek açılım ya da çift açılım tandem raylarla kullanılabilir.
- 2 farklı modül genişliğine uygun sepetler krom kaplamalıdır.

- Available under-counter hinged cabinets with door or mounted module covers.
- Carrying capacity 15 kg.
- Can be used with standart, single-extension soft close or full-extension soft close tandem rails.
- Baskets with 2 different module sizes are chrome plated.

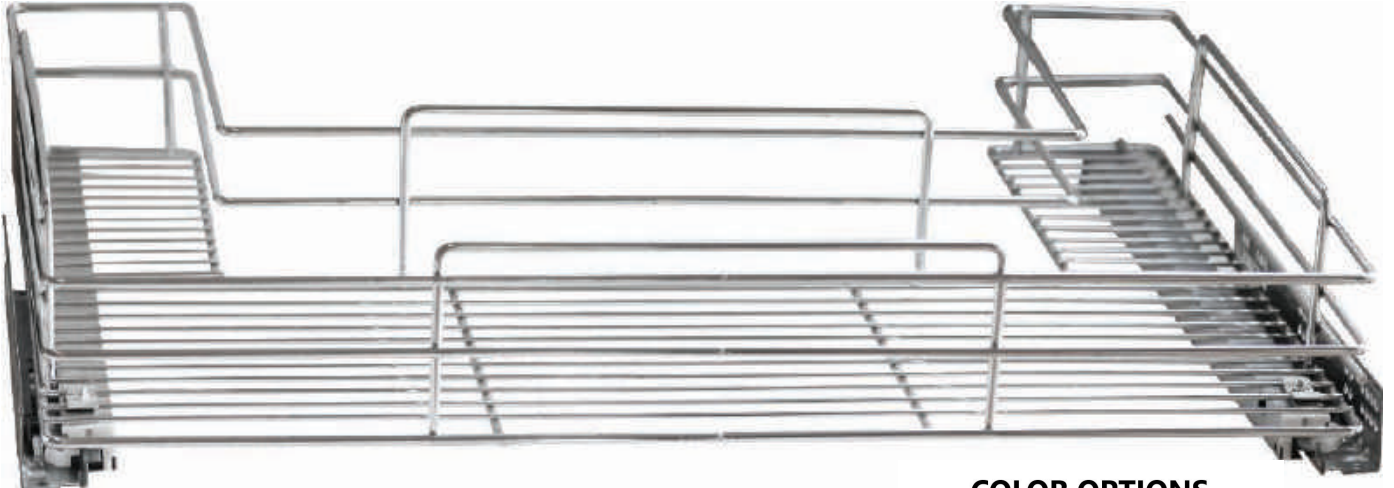

COLOR OPTIONS

CHROME
CODE: XXXXX

ANTHRACITE
CODE: XXXXX-A

Tandem raylı eviye altı çekmece / Tandem sink drawer

Ürün Kodu / Product Code	Tip / Type	Ölçüler / Size GxDxY / WxDxH (mm)	Modül / Modul (mm)	Hacim / Volume (m3)	Ağırlık / Weight (kg)
61001	Çift açılım frenli / full extension soft close	764 x 500 x 110	80	0,10	5,00
61005	Çift açılım frenli / full extension soft close	864 x 500 x 110	90	0,12	6,00

COLOR OPTIONS

CHROME
CODE: XXXXX

ANTHRACITE
CODE: XXXXX-A

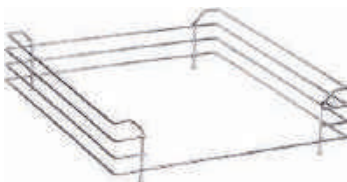

KOD: 68205

Çekmece çerçevesi / Drawer frame

Ürün Kodu / Product Code	Ölçüler / Size GxDxY / WxDxH (mm)	Modül / Modul (mm)	Hacim / Volume (m3)	Ağırlık / Weight (kg)
68203	280 x 500 x 120	35	0,01	1,20
68204	330 x 500 x 120	40	0,01	1,40
68205	380 x 500 x 120	45	0,01	1,60
68206	430 x 500 x 120	50	0,02	1,80
68207	480 x 500 x 120	55	0,02	2,00

TSEK

DOMODEK®

Alüminyum frenli raylı çekmece / Aluminium drawer soft closing



KOD: 91202

- Evye altlarının değerlendirilmesine yardımcı olur.
- Bağlanılan kabinin kapağı hem menteşeli hem de ürüne monte olabilir.
- Kullanılan raylar yavaş ve sessiz otomatik kapanış sağlar.
- Elokso kaplıdır. Paslanmaz.
- Sepet tabanı 8mm MDFLAM' dir.

- Available under-sink cabinets.
- Available both hinged cabinets with door and door fasteners to the module.
- Rails provide silent and smooth closing.
- Surfaces are Anodising plated.
- Basket floors are made of 8mm MDF.



KOD: 91202

SOFT CLOSE (Frenli)

Alüminyum eviye altı frenli raylı çekmece / Aluminium sink drawer soft closing

Ürün Kodu / Product Code	Ölçüler / Size GxDxY / WxDxH (mm)	Modül / Modul (mm)	Hacim / Volume (m3)	Ağırlık / Weight (kg)
91201	763 x 503 x 133	80	0,05	5,20
91202	863 x 503 x 133	90	0,06	5,60

TSEK

DOMODEK®



- Tezgahaltında ister menteşeli kapakla ister ürüne monte kapakla kullanılabilir.
- Kullanılan raylar yavaş ve sessiz otomatik kapanış sağlar.
- Elokso kaplıdır. Paslanmaz.
- Sepet tabanı 8mm MDFLAM' dir.

- Available both hinged cabinets with door and door fasteners to the module.
- Rails provide silent and smooth closing.
- Surfaces are Anodising plated.
- Basket floors are made of 8mm MDF.



KOD: 91212

SOFT CLOSE (Frenli)

Alüminyum frenli raylı çekmece / Aluminium drawer soft closing

Ürün Kodu / Product Code	Ölçüler / Size GxDxY / WxDxH (mm)	Modül / Modul (mm)	Hacim / Volume (m3)	Ağırlık / Weight (kg)
91211	313 x 503 x 175	35	0,03	4,00
91212	363 x 503 x 175	40	0,03	4,25
91213	413 x 503 x 175	45	0,04	4,50
91214	463 x 503 x 175	50	0,04	4,75
91215	513 x 503 x 175	55	0,05	5,00

TSEK

DOMODEK®

Alüminyum frenli tezgah altı / Aluminium under counter soft closing



- Tezgahaltında ister menteşeli kapakla ister ürüne monte kapakla kullanılabilir.
- Alt mekanizmadaki üstün tasarım, montajda kolaylık ve zaman tasarrufu sağlar.
- Alt mekanizmadaki raylar ve yan destek rayı yavaş ve sessiz otomatik kapanış sağlar.
- 5 farklı modül genişliğine uygun ölçüler mevcuttur.
- Eloksal kaplıdır. Paslanmaz.
- Sepet tabanı 8mm MDFLAM' dir.

SOFT CLOSE (Frenli)

Alüminyum frenli tezgah altı grubu / Aluminium under counter unit closing bottom tied

Ürün Kodu / Product Code	Ölçüler / Size GxDxY / WxDxH (mm)	Modül / Modul (mm)	Hacim / Volume (m3)	Ağırlık / Weight (kg)
91141	287 x 503 x 525	35	0,08	8,70
91142	337 x 503 x 525	40	0,09	9,40
91143	387 x 503 x 525	45	0,10	10,10
91144	437 x 503 x 525	50	0,12	10,80
91145	487 x 503 x 525	55	0,13	10,50

Alüminyum frenli şişelikli tezgah altı / Aluminium under counter with bottle soft closing



- Available both hinged cabinets with door and door fasteners to the module.
- Excellent design of the bottom mechanism provides you an easy assembly and time saving.
- Rails at the bottom mechanism provide silent and smooth closing.
- There are five module options.
- Surfaces are Anodising plated.
- Basket floors are made of 8mm MDF.

SOFT CLOSE (Frenli)

Alüminyum frenli şişelikli tezgah altı grubu / Aluminium under counter unit with bottle folder soft closing

Ürün Kodu / Product Code	Ölçüler / Size GxDxY / WxDxH (mm)	Modül / Modul (mm)	Hacim / Volume (m3)	Ağırlık / Weight (kg)
91151	287 x 503 x 525	35	0,08	8,70
91152	337 x 503 x 525	40	0,09	9,40
91153	387 x 503 x 525	45	0,10	10,10
91154	437 x 503 x 525	50	0,12	10,80
91155	487 x 503 x 525	55	0,13	11,50

2 years
guarantee



KOD: 39141

Tezgah altı grubu / Under counter units

- Tezgah altında, kapağa monte edilerek kullanılır.
 - Taşıma kapasitesi 15 kg dır.
 - İster bilyalı teleskobik rayla ister yavaş ve sessiz kapanma sağlayan soft close teleskobik rayla kullanılabilir.
 - Demonte sepetler mekanizmalara monte edilerek kullanılır.
 - Sepetler krom kaplamalıdır, mekanizmalar gri boyalıdır.
- Available under-counter mounted module covers.
• Carrying capacity 15 kg.
• Can be used with ball bearing telescopic rails or soft close telescopic rails which provides silent and smooth closing.
• Unmounted baskets can be fix to mechanism.
• Baskets are chrome plated, mechanisms are painted gray.

COLOR OPTIONS

CHROME
CODE: XXXXX

ANTHRACITE
CODE: XXXXX-A



KOD: 39811



KOD: 39821



KOD: 39801

Tezgah altı sebzelik / Telescopic under counter

Ürün Kodu / Product Code	Tip / Type	Ölçüler / Size GxDxY / WxDxH (mm)	Modül / Modul (mm)	Hacim / Volume (m3)	Ağırlık / Weight (kg)
39801	Frenli 2 sepet ekmeklikli / Soft close 2 baskets with bread bag	300 x 500 x 500	35	0,03	6,00
39802	Frenli 2 sepet ekmeklikli / Soft close 2 baskets with bread bag	350 x 500 x 500	40	0,03	6,30
39803	Frenli 2 sepet ekmeklikli / Soft close 2 baskets with bread bag	400 x 500 x 500	45	0,03	6,60
39804	Frenli 2 sepet ekmeklikli / Soft close 2 baskets with bread bag	550 x 500 x 500	60	0,03	7,50
39811	Frenli 2 sepetli tabaklıklılı / Soft close 2 baskets ith dish holder	300 x 500 x 500	35	0,03	6,00
39812	Frenli 2 sepetli tabaklıklılı / Soft close 2 baskets ith dish holder	350 x 500 x 500	40	0,03	6,30
39813	Frenli 2 sepetli tabaklıklılı / Soft close 2 baskets ith dish holder	400 x 500 x 500	45	0,03	6,60
39814	Frenli 2 sepetli tabaklıklılı / Soft close 2 baskets ith dish holder	550 x 500 x 500	60	0,03	7,50
39821	Frenli 2 sepetli şişelikli / Soft close 2 baskets with bottle holder	300 x 500 x 500	35	0,03	6,00
39822	Frenli 2 sepetli şişelikli / Soft close 2 baskets with bottle holder	350 x 500 x 500	40	0,03	6,30
39823	Frenli 2 sepetli şişelikli / Soft close 2 baskets with bottle holder	400 x 500 x 500	45	0,03	6,60
39826	Frenli 2 sepetli şişelikli / Soft close 2 baskets with bottle holder	550 x 500 x 500	60	0,03	7,50
39141	Frenli 3 sepetli / Soft close 3 baskets	300 x 500 x 500	35	0,03	8,00
39142	Frenli 3 sepetli / Soft close 3 baskets	350 x 500 x 500	40	0,03	8,30
39143	Frenli 3 sepetli / Soft close 3 baskets	400 x 500 x 500	45	0,03	8,70
39144	Frenli 3 sepetli / Soft close 3 baskets	550 x 500 x 500	60	0,03	9,00

Mutfak aksesuarları grubu / Kitchen accessories group



- Tezgahüstü grubundaki ürünlerin montajında kullanılırlar.
- Borular tapalı ve krom kaplamadır.

- Used for the assembly of over-counter units.
- Pipes have caps and are chrome plated.

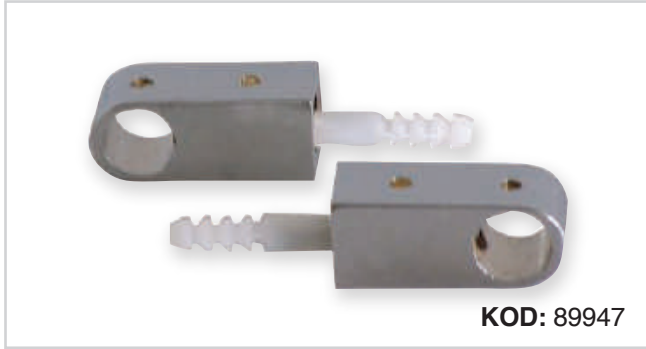

KOD: 89947



KOD: 89948



KOD: 89949



COLOR OPTIONS

KOD: 88910

CHROME
CODE: XXXXX

ANTHRACITE
CODE: XXXXX-A

Set arası askı grubu / Midway set hang group

Ürün Kodu / Product Code	Ürün Adı / Product Name	Koli içi ad. / In box	Hacim / Volume (m3)	Ağırlık / Weight (kg)
89149	tapalı boru 40 cm / pipe with tube plug 40 cm	10	0,01	0,15
89150	tapalı boru 50 cm / pipe with tube plug 50 cm	10	0,01	0,19
89151	tapalı boru 60 cm / pipe with tube plug 60 cm	10	0,01	0,22
89152	tapalı boru 80 cm / pipe with tube plug 80 cm	10	0,01	0,29
89153	tapalı boru 100 cm / pipe with tube plug 100 cm	10	0,01	0,36
89154	tapalı boru 120 cm / pipe with tube plug 120 cm	10	0,01	0,44
88910	50 cm boru bağlantı kanca set / 50 cm pipe connector hook set		0,01	0,36
89947	bağlantı takım / connector set		0,01	0,01
89948	tekli kanca / single hook		0,01	0,01
89949	ikili kanca / double hook		0,01	0,01



KOD: 88801



KOD: 88802



KOD: 88803



KOD: 80801



KOD: 88802



KOD: 88803

- Ürünler krom kaplamadır.
- Plastik tapalar mevcuttur.
- Set olan ürünlerimize boru ve bağlantılar dahildir.

- Products are chrome plated.
- Plastic caps are available.
- Pipe and connectors are included in sets.

COLOR OPTIONS

CHROME
CODE: XXXXX

ANTHRACITE
CODE: XXXXX-A

Havluluk - folyoluk / Towel - foil paper

Ürün Kodu / Product Code	Tip / Type	Ölçüler / Size GxDxY / WxDxH (mm)	Koli içi ad. / In box	Hacim / Volume (m3)	Ağırlık / Weight (kg)
80801	üçlü / triple	320 x 150 x 370	10	0,22	1,50
80802	ikili / double	320 x 150 x 300	10	0,22	1,30
80803	tekli / single	320 x 150 x 260	10	0,22	1,20
88801	üçlü / triple (SET)	320 x 150 x 370	8	0,22	2,00
88802	ikili / double (SET)	320 x 150 x 300	8	0,22	1,80
88803	tekli / single (SET)	320 x 150 x 260	8	0,22	1,70



KOD: 88804



KOD: 88808



KOD: 88809



KOD: 81804



KOD: 83808



KOD: 83809

- Ürünler krom kaplamadır.
- Plastik tapalar mevcuttur.
- Set olan ürünlerimize boru ve bağlantılar dahildir.

- Products are chrome plated.
- Plastic caps are available.
- Pipe and connectors are included in sets.

COLOR OPTIONS

CHROME
CODE: XXXXX

ANTHRACITE
CODE: XXXXX-A

Baharatlık / Spice holder

Ürün Kodu / Product Code	Tip / Type	Ölçüler / Size GxDxY / WxDxH (mm)	Koli içi ad. / In box	Hacim / Volume (m3)	Ağırlık / Weight (kg)
81804	klasik / classic	320 x 170 x 330	10	0,22	1,50
83808	uzun / long	325 x 170 x 370	10	0,22	1,30
83809	kısa / short	330 x 170 x 290	10	0,22	1,20
88804	klasik / classic (SET)	320 x 170 x 330	8	0,22	2,00
88808	uzun / long (SET)	325 x 170 x 370	8	0,22	1,80
88809	kısa / short (SET)	330 x 170 x 290	8	0,22	1,70

Mutfak aksesuarları grubu / Kitchen accessories group



KOD: 88090



KOD: 88070



KOD: 85090



KOD: 85070

COLOR OPTIONS

CHROME
CODE: XXXXX

ANTHRACITE
CODE: XXXXX-A

- Ürünler krom kaplamadır.
- Plastik tapalar mevcuttur.
- Set olan ürünlerimize boru ve bağlantılar dahildir.

- Products are chrome plated.
- Plastic caps are available.
- Pipe and connectors are included in sets.

Geçmeli tabaklık - bardaklık / Dish-glass holder

Ürün Kodu / Product Code	Tip / Type	Ölçüler / Size GxDxY / WxDxH (mm)	Koli içi ad. / In box	Hacim / Volume (m3)	Ağırlık / Weight (kg)
85070	mini / mini	360 x 290 x 440	10	0,22	2,00
85090	uzun / long	520 x 290 x 440	10	0,22	3,00
88070	mini / mini (SET)	360 x 290 x 440	6	0,22	2,50
88890	uzun / long (SET)	520 x 290 x 440	6	0,22	3,50



KOD: 88092



KOD: 88093



KOD: 88094

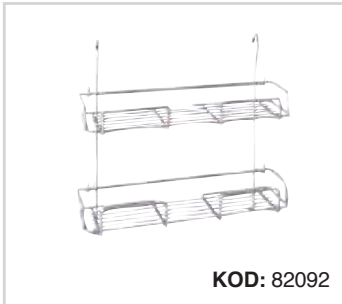

KOD: 82092



KOD: 82093

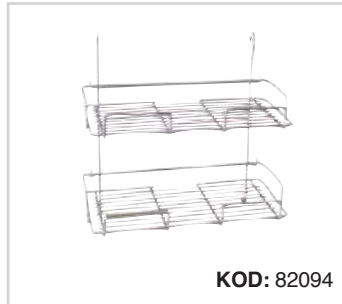

KOD: 82094

COLOR OPTIONS

CHROME
CODE: XXXXX

ANTHRACITE
CODE: XXXXX-A

Geçmeli bardaklık / Glass holder

Ürün Kodu / Product Code	Tip / Type	Ölçüler / Size GxDxY / WxDxH (mm)	Koli içi ad. / In box	Hacim / Volume (m3)	Ağırlık / Weight (kg)
82092	dar-dar / tight-tight	520 x 160 x 440	10	0,22	1,80
82093	dar-geiş / tight-wide	520 x 240 x 440	10	0,22	2,20
82094	geniş-geiş / wide-wide	520 x 240 x 440	10	0,22	2,50
88092	dar-dar / tight-tight (SET)	520 x 160 x 440	6	0,22	2,30
88093	dar-geiş / tight-wide (SET)	520 x 240 x 440	6	0,22	2,70
88094	geniş-geiş / wide-wide (SET)	520 x 240 x 440	6	0,22	3,00



KOD: 88872



KOD: 88805



KOD: 84872



KOD: 83805

- Ürünler krom kaplamadır.
- Plastik tapalar mevcuttur.
- Set olan ürünlerimize boru ve bağlantılar dahildir.

- Products are chrome plated.
- Plastic caps are available.
- Pipe and connectors are included in sets.

COLOR OPTIONS

CHROME
CODE: XXXXX

ANTHRACITE
CODE: XXXXX-A

Askılı ürünler / Hanged products

Ürün Kodu / Product Code	Tip / Type	Ölçüler / Size GxDxY / WxDxH (mm)	Koli içi ad. / In box	Hacim / Volume (m3)	Ağırlık / Weight (kg)
84872	kaşıklik / spoon holder	100 x 100 x 330	10	0,22	0,60
88872	kaşıklik / spoon holder (SET)	100 x 100 x 330	8	0,22	1,10
83805	köşe raf tekli / corner shelf	320 x 330 x 370	10	0,22	1,50
88805	köşe raf tekli / corner shelf (SET)	320 x 330 x 370	6	0,22	2,00



KOD: 88001

COLOR OPTIONS

CHROME
CODE: XXXXX

ANTHRACITE
CODE: XXXXX-A

- 3lü havluluk, klasik baharatlık, 80cm boru, 5 adet kanca ve bağlantılı elamanlarından oluşan bir settir.
- Tüm ürünler krom kaplamadır.
- Plastik tapalar mevcuttur.

- This set includes a triple towel rack, a spice holder, a 80cm pipe, 5 hooks and connectors.
- All products in this set are chrome plated.
- Plastic caps are available.



KOD: 88001

Askılı ürünler / Hanged products

Ürün Kodu / Product Code	Tip / Type	Ölçüler / Size GxDxY / WxDxH (mm)	Koli içi ad. / In box	Hacim / Volume (m3)	Ağırlık / Weight (kg)
88001	Set 1 / Set 1	750 x 185 x 375	4	0,20	4,60

Mutfak aksesuarları grubu / Kitchen accessories group



KOD: 80804



KOD: 84084

COLOR OPTIONS

CHROME
CODE: XXXXX

ANTHRACITE
CODE: XXXXX-A

Set üstü ürünler / Accessories

Ürün Kodu / Product Code	Tip / Type	Ölçüler / Size GxDxY / WxDxH (mm)	Koli içi ad. / In box	Hacim / Volume (m3)	Ağırlık / Weight (kg)
80804	kule havluluk / tower towel rack	320 x 150 x 130	20	0,22	0,35
84084	tencere altı / hot pot	150 x 200 x 50	20	0,22	0,55



KOD: 83811



KOD: 86076

Aksesuar / Accessories

Ürün Kodu / Product Code	Tip / Type	Ölçüler / Size GxDxY / WxDxH (mm)	Koli içi ad. / In box	Hacim / Volume (m3)	Ağırlık / Weight (kg)
83811	kapak arkası raf / secret shelf	320 x 100 x 380	10	0,22	1,50



- Yıkamış bulaşıklarınızı organize etmekte yardımcı olur.
- Plastik tepsi ve kaşıklık mevcuttur.
- Tüm ürünler krom kaplamadır.

- Helps to organize your washed dishes.
- Plastic plate and spoon holder are available
- All products are chrome plated.

COLOR OPTIONS

CHROME
CODE: XXXXX

ANTHRACITE
CODE: XXXXX-A



KOD: 86074



KOD: 86073



KOD: 86072

Tabaklık grubu / Dish holder

Ürün Kodu / Product Code	Tip / Type	Ölçüler / Size GxDxY / WxDxH (mm)	Koli içi ad. / In box	Hacim / Volume (m3)	Ağırlık / Weight (kg)
86074	tekli krom tabaklık / dish holder single	360 x 440 x 130	6	0,22	1,85
86073	iki katlı krom tabaklık / dish holder double	360 x 440 x 240	4	0,22	2,70
86072	uzun krom tabaklık / dish holder long	370 x 785 x 250	4	0,22	3,35
86076	demonte krom tabaklık dish holder demounted	360 x 440 x 120	6	0,11	2,20

Mutfak aksesuarları grubu / Kitchen accessories group



KOD: 39034

- İster mutfađınızda ister banyonuzda eşyalarınızı düzenli şekilde tutmanızı sağlar.
- Demonte sepetleri borulara kolayca montaj edebilirsiniz.
- Can be used in kitchen or bathroom.
- Unmounted baskets can be fix to the pipes easily.

COLOR OPTIONS

CHROME
CODE: XXXXX

ANTHRACITE
CODE: XXXXX-A

Sebzelik servis ünitesi / Service unit

Ürün Kodu / Product Code	Tip / Type	Ölçüler / Size GxDxY / WxDxH (mm)	Koli içi ad. / In box	Hacim / Volume (m3)	Ağırlık / Weight (kg)
39034	dört katlı plastik / tetrad plastic	350 x 450 x 850	4	0,22	4,00

Dolap içi tabaklık-bardaklık / Plate -glass shelf

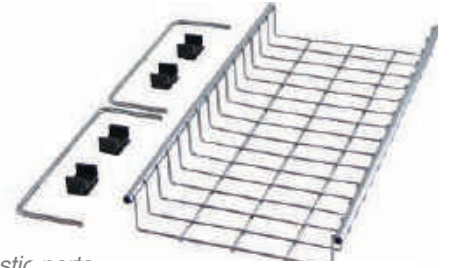
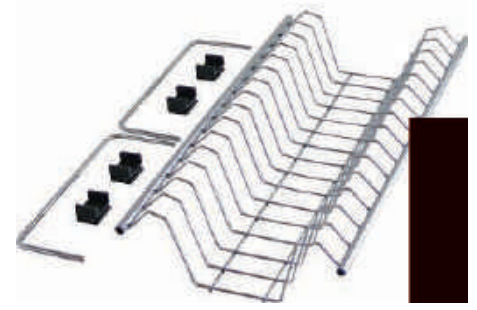
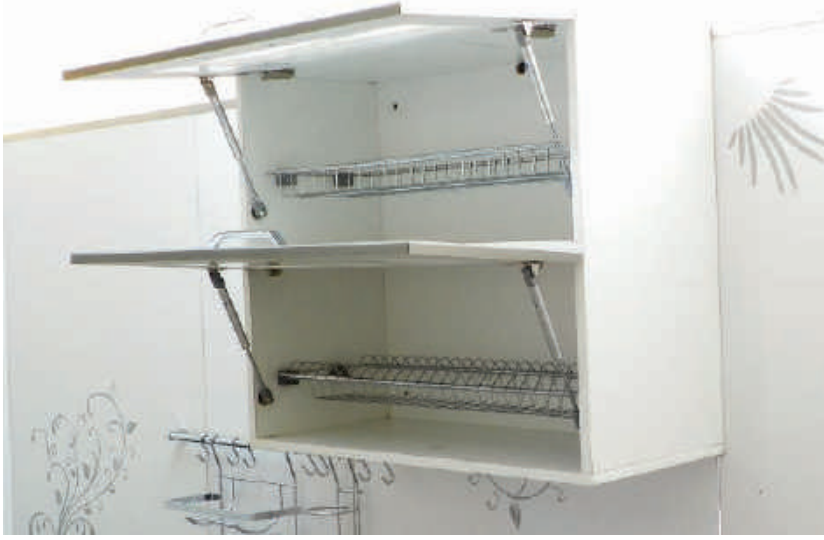

- Plastik aparatlarla dolap yanlarına bağlanır. • Fixed to the sides of the cabinet with plastic brackets.
- Sabit ya da ayarlanabilir özelliklidir. • Can be fixed or adjustable.
- Sepetler krom kaplamadır. • Baskets are chrome plated.

COLOR OPTIONS

CHROME
CODE: XXXXX

ANTHRACITE
CODE: XXXXX-A

Ayarlanabilir tabaklık-bardaklık / Adjustable plate-glass holder

Ürün Kodu / Product Code	Tip / Type	Modül / Modul	Ölçüler / Size GxDxY / WxDxH (mm)	Koli içi ad. / In box	Hacim / Volume (m3)	Ağırlık / Weight (kg)
45010	tabaklık / dish holder	55-60	500 x 250 x 80	10	0,07	0,85
45011	tabaklık / dish holder	65-70	600 x 250 x 80	10	0,09	1,00
45012	tabaklık / dish holder	75-80	700 x 250 x 80	10	0,09	1,15
45013	tabaklık / dish holder	85-90	800 x 250 x 80	10	0,12	1,30
45014	tabaklık / dish holder	95-100	900 x 250 x 80	10	0,12	1,45
40010	bardaklık / glass holder	55-60	500 x 250 x 80	10	0,07	0,80
40011	bardaklık / glass holder	65-70	600 x 250 x 80	10	0,09	0,95
40012	bardaklık / glass holder	75-80	700 x 250 x 80	10	0,09	1,10
40013	bardaklık / glass holder	85-90	800 x 250 x 80	10	0,12	1,25
40014	bardaklık / glass holder	95-100	900 x 250 x 80	10	0,12	1,40



Damlalıklı tabaklık-bardaklık / Dish&bottle with dropper

Ürün Kodu / Product Code	Tip / Type	Modül / Modul	Ölçüler / Size GxDxY / WxDxH (mm)	Koli içi ad. / In box	Hacim / Volume (m3)	Ağırlık / Weight (kg)
40141	bardaklık / glass holder	60	564 x 250 x 80	10	0,07	1,00
45141	tabaklık / dish holder	60	564 x 250 x 80	10	0,09	1,15
40143	bardaklık / glass holder	80	764 x 250 x 80	10	0,09	1,30
45143	tabaklık / dish holder	80	764 x 250 x 80	10	0,12	1,45
42141	tabaklık-bardaklık (SET) / dish and glass holder (SET)	60	564 x 250 x 80	1	0,02	2,15
44141	tabaklık-bardaklık (SET) / dish and glass holder (SET)	80	764 x 250 x 80	1	0,02	2,75

COLOR OPTIONS

CHROME
CODE: XXXXX

ANTHRACITE
CODE: XXXXX-A



- Mutfaklarınıza ya da salonlarınıza dekoratif çözüm sunar.
- 4 farklı boru seçeneğiyle istediğiniz yerde kullanabilirsiniz.
- 5 farklı sepet seçeneği mevcuttur.
- Metal flanşlar dahildir.
- Sepetler, boru ve metal flanşlar krom kaplamadır.

- Provides decorative solutions to your kitchens or living rooms.
- 4 different pipe lengths are available.
- 5 different baskets are available.
- Metal flanges are included.
- Baskets, pipes and metal flanges are chrome plated



KOD: 53310



KOD: 53318



KOD: 53312



KOD: 53320



KOD: 53316



KOD: 533344

KOD: 53344



boru ile birlikte verilir. comes with the pipe.

Bar grubu / Bar group

Ürün Kodu / Product Code	Tip / Type	Ölçüler / Size GxDxY / WxDxH (mm)	Koli içi ad. / In box	Hacim / Volume (m3)	Ağırlık / Weight (kg)
53302	barborusu / bar pipe	1000 x (Ø) 42,5	1	0,01	4,30
53304	barborusu / bar pipe	1300 x (Ø) 42,5	1	0,01	4,60
53305	barborusu / bar pipe	1500 x (Ø) 42,5	1	0,02	5,00
53306	barborusu / bar pipe	2100 x (Ø) 42,5	1	0,02	5,40
53344	duvar bağlantısı / wall connector		5	0,08	0,80
53310	pleksi taban / plexy round	90x (Ø) 365	5	0,08	2,10
53312	ağşap taban / wooden round	70x (Ø) 365	5	0,08	2,10
53316	hasır döner taban / wire round	55x (Ø) 365	5	0,08	1,40
53318	hasır üçgen taban / wire triangle round	55x (Ø) 365	5	0,08	1,20
53320	kadehlik / drinking glass holder	70x (Ø) 365	5	0,08	1,30

COLOR OPTIONS

CHROME
CODE: XXXXX

ANTHRACITE
CODE: XXXXX-A

Bar grubu / Bar group



KOD: 53450

Bar grubu / Bar group

Ürün Kodu / Product Code	Tip / Type	Ölçüler / Size GxDxY / WxDxH (mm)	Koli içi ad. / In box	Hacim / Volume (m3)	Ağırlık / Weight (kg)
53450	bar standı / bar stand	720 x 350 x 350	1	0,07	5,40



COLOR OPTIONS

CHROME
CODE: XXXXX

ANTHRACITE
CODE: XXXXX-A

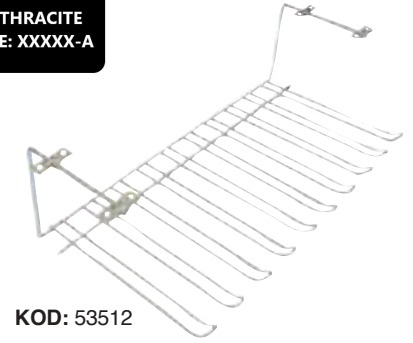

KOD: 53512



KOD: 53517



KOD: 53516



KOD: 53515

Bar grubu / Bar group

Ürün Kodu / Product Code	Tip / Type	Ölçüler / Size GxDxY / WxDxH (mm)	Koli içi ad. / In box	Hacim / Volume (m3)	Ağırlık / Weight (kg)
53515	lamalı kadehlik tekli / single sheet	225 x 357 x 60	30	0,12	0,25
53516	lamalı kadehlik ikili / double sheet	265 x 357 x 60	20	0,12	0,55
53517	lamalı kadehlik üçlü / triple sheet	395 x 357 x 60	10	0,12	0,85
53512	sabit kadehlik / fixed sheet	460 x 240 x 150	20	0,12	0,90

2 years
guarantee



KOD: 79083

Banyo aksesuarları grubu / Bath accessories



Askılı çamaşır sepeti / Hooked laundry basket

Ürün Kodu / Product Code	Modül / Modul	Ölçüler / Size GxDxY / WxDxH (mm)	Koli içi ad. / In box	Hacim / Volume (m3)	Ağırlık / Weight (kg)
79377	300	230 x 315 x 500	4	0,177	2,45
79378	350	280 x 315 x 500	4	0,212	2,85
79379	400	330 x 315 x 500	4	0,247	3,10
79380	450	380 x 315 x 500	4	0,281	3,35
79381	500	430 x 315 x 500	4	0,316	3,65
79382	550	480 x 315 x 500	4	0,342	3,75
79383	600	530 x 315 x 500	4	0,368	3,85

COLOR OPTIONS

CHROME
CODE: XXXXX

ANTHRACITE
CODE: XXXXX-A

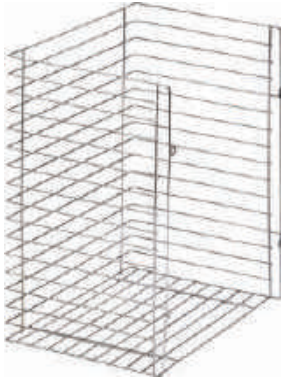

Kapağa monte çamaşır sepeti / Laundry basket

Ürün Kodu / Product Code	Tip / Type	Modül / Modul	Ölçüler / Size GxDxY / WxDxH (mm)	Koli içi ad. / In box	Hacim / Volume (m3)	Ağırlık / Weight (kg)
79080		300	230 x 250 x 500	8	0,12	0,80
79081		350	280 x 250 x 500	8	0,12	0,90
79082		400	330 x 250 x 500	8	0,12	1,30
79083		450	380 x 250 x 500	8	0,12	1,50
79084		500	430 x 250 x 500	8	0,12	1,50
79085		550	480 x 250 x 500	8	0,15	1,70
79086		600	530 x 250 x 500	8	0,15	1,90
79087		650	580 x 250 x 500	8	0,15	2,10

COLOR OPTIONS

CHROME
CODE: XXXXX

ANTHRACITE
CODE: XXXXX-A



Banyo köşe / Bath corner

Ürün Kodu / Product Code	Tip / Type	Ölçüler / Size GxDxY / WxDxH (mm)	Koli içi ad. / In box	Hacim / Volume (m3)	Ağırlık / Weight (kg)
79410	ikili / single	310 x 230 x 315	20	0,22	1,10
79412	üçle / triple	310 x 230 x 525	16	0,22	1,40

Gardrop grubu / Wardrop group

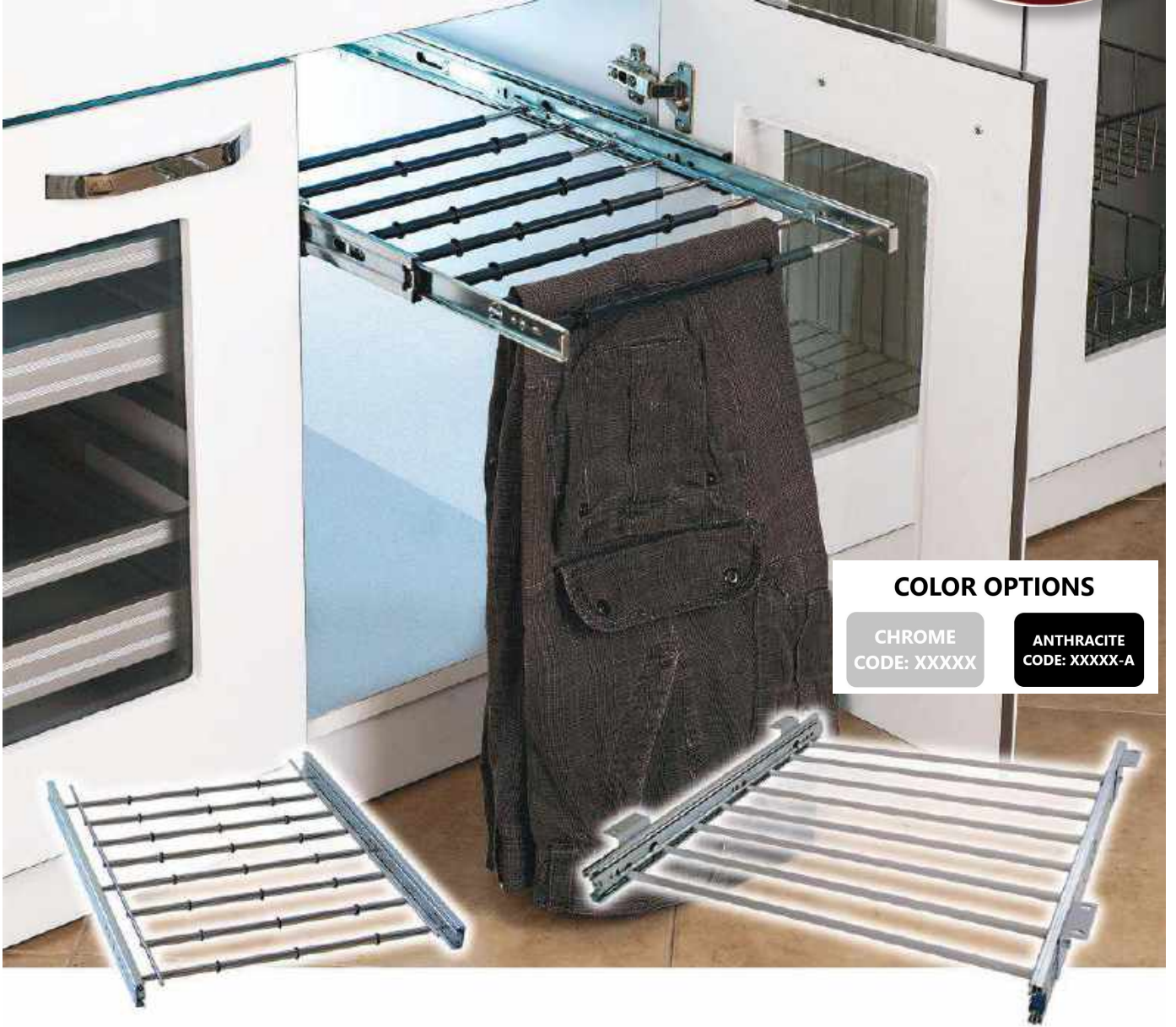

COLOR OPTIONS

CHROME
CODE: XXXXX

ANTHRACITE
CODE: XXXXX-A

Pantolon askısı grubu / Panth holder

Modül / Modul	Ölçüler / Size GxDxY / WxDxH (mm)	Koli içi ad. / In box	Hacim / Volume (m3)	Yandan bağlantılı pantolon askısı grubu Side Tied Tis Panth Holder		Tavan bağlantılı pantolon askısı grubu Top Tied Tis Panth Holder	
				Ürün Kodu / Product Code	Ağırlık / Weight (kg)	Ürün Kodu / Product Code	Ağırlık / Weight (kg)
30-35	260 x 500 x 30	5	0,03	75116	1,95	75216	2,20
35-40	310 x 500 x 30	5	0,04	75117	2,05	75217	2,30
40-45	360 x 500 x 30	5	0,04	75118	2,15	75218	2,40
45-50	410 x 500 x 30	5	0,05	75119	2,25	75219	2,50
50-55	460 x 500 x 30	5	0,05	75120	2,35	75220	2,60
55-60	510 x 500 x 30	5	0,07	75121	2,45	75221	2,70
60-65	560 x 500 x 30	5	0,07	75122	2,55	75222	2,80
65-70	610 x 500 x 30	5	0,07	75123	2,65	75223	2,90
70-75	660 x 500 x 30	5	0,09	75124	2,75	75224	3,00
75-80	710 x 500 x 30	5	0,09	75125	2,85	75225	3,10
80-85	760 x 500 x 30	5	0,09	75126	2,95	75226	3,20
85-90	810 x 500 x 30	5	0,10	75127	3,05	75227	3,30
90-95	860 x 500 x 30	5	0,10	75128	3,15	75228	3,40
95-100	910 x 500 x 30	5	0,10	75129	3,25	75229	3,50
100-105	960 x 500 x 30	5	0,10	75130	3,35	75230	3,60

Gardrop grubu / Wardrop group

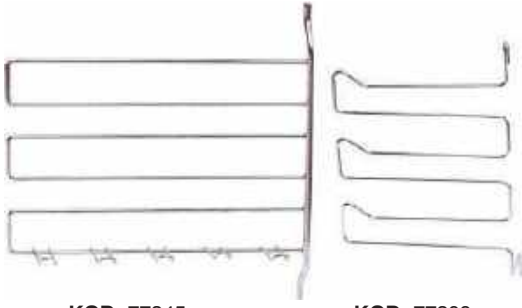

KOD: 77345

KOD: 77309



KOD: 77307

KOD: 77305

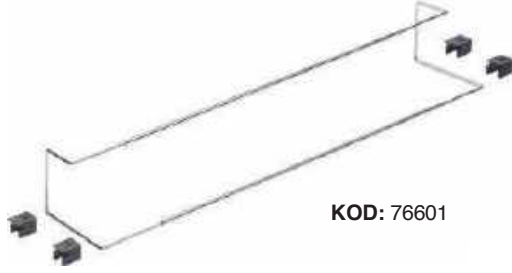

KOD: 76601

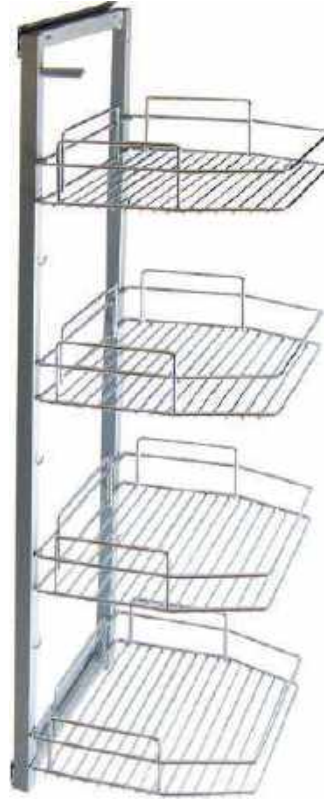

KOD: 78525



KOD: 78628

COLOR OPTIONS

CHROME
CODE: XXXXX

ANTHRACITE
CODE: XXXXX-A

Kravatlık / Tie holder

Ürün Kodu / Product Code	Tip / Type	Ölçüler / Size GxDxY / WxDxH (mm)	Koli içi ad. / In box	Hacim / Volume (m3)	Ağırlık / Weight (kg)
77305	tekli / single	250 x 100 x 180	30	0,12	0,40
77307	ikili / double	250 x 100 x 270	20	0,12	0,50
77309	üçlü / triple	250 x 100 x 390	10	0,12	0,60
77345	menteşeli / with flap	320 x 80 x 330	10	0,12	2,30

Ayakkabılık / Shoe holder

Ürün Kodu / Product Code	Tip / Type	Ölçüler / Size GxDxY / WxDxH (mm)	Koli içi ad. / In box	Hacim / Volume (m3)	Ağırlık / Weight (kg)
76601	ayarlı ayakkabılık / adj. shoe holder	460 x 190 x 130	10	0,12	0,80

Gardrop sepeti / Wardrop basket

Ürün Kodu / Product Code	Tip / Type	Modül / Modul	Ölçüler / Size GxDxY / WxDxH (mm)	Koli içi ad. / In box	Hacim / Volume (m3)	Ağırlık / Weight (kg)
78525	tango raylı / tango ralled	45	370 x 390 x 1110	1	0,13	10,00
78535	tango sabit / tango ralled	45	370 x 370 x 1110	1	0,13	8,90
78625	vals döner / walz revolving	60	460 x 460 x 1250	1	0,13	6,80
78628	vals döner / walz revolving	60	560 x 560 x 1250	1	0,13	7,40
78631	vals döner / walz revolving	80	720 x 720 x 1250	1	0,13	8,60

Sertifikalarımız / Our Certifications



СИСТЕМА СЕРТИФИКАЦИИ ГОСТ Р
ФЕДЕРАЛЬНОЕ АГЕНТСТВО ПО ТЕХНИЧЕСКОМУ РЕГУЛИРОВАНИЮ И МЕТРОЛОГИИ

СЕРТИФИКАТ СООТВЕТСТВИЯ

№ РОСС TR_ДЕ01.Н38643
Срок действия с 24.06.2013г. по 23.06.2016г.
№ 0651535

ОРГАН ПО СЕРТИФИКАЦИИ
РОСС DE.0001.11.ДЕ01
ДИН ГОСТ ТРОФ БЕРЛИН-БРАНДЕНБУРГ Общество по сертификации в Европе,
Будденштер Штр. 11, 10787 Берлин, Германия, Тел: +49302401 2110 Факс: +49302401 1716, info@din-gost.ru

ПРОДУКЦИЯ
изделия из алюминия и вальцы из черных металлов (Сталь или Алюминий), хромированные: подокон. стеллажи, сетки, держатели, полки-корпусы, бутылочницы, корзинки, хромовые вставки, вешалки
сертификат выдан: **СООТВЕТСТВУЕТ ТРЕБОВАНИЯМ НОРМАТИВНОГО ДОКУМЕНТА ГОСТ Р 51687-2000.**

ИЗГОТОВИТЕЛЬ
DOMODEK NURETT'YN SEVG'YN
KOS'BY ANKARA ASFALTI 26.KM KEMALPAŞA / İZMİR

СЕРТИФИКАТ ВЫДАН
DOMODEK NURETT'YN SEVG'YN
KOS'BY ANKARA ASFALTI 26.KM KEMALPAŞA / İZMİR

НА ОСНОВАНИИ
сертификата № 0110-13 от 19.06.2013 г., выданного

МІНІСТЕРСТВО ОХОРОНИ ЗДОРОВ'Я УКРАЇНИ
ДЕРЖАВНА САНІТАРНО-ЕПІДЕМІОЛОГІЧНА СЛУЖБА

ЗАТВЕРДЖУЮ

Міністерство охорони здоров'я України
(назва установи)
вул.Грушевського, 7, м.Київ, 01601
(адреса установи)
253-94-84, 859-20-88

Перший заступник голови ДС
О.П. Коваленко

к державної санітарно-епідеміологічної експертизи

24. 2015р. № 05.03.02-03/ 22295

техн. тримачі, поліетиленові, бутылочні, корзинки, гачки, решітки, тримачі стіла, алюміній хромований

муніцип. асфальт, асфальтні покриття

TIN SEVG'YN, Туреччина, KOS'BY ANKARA ASFALTI 26.KM KEMALPAŞA / İZMİR

TIN SEVG'YN, Туреччина, KOS'BY ANKARA ASFALTI 26.KM KEMALPAŞA / İZMİR

до документів, що супроводжують вантаж

цього вантажу: металеві: металеві критерії безпеки / алюминий:

на використання / застосування, зберігання, транспортування, утилізації вантажу

якщо продукції необхідно дотримуватися вимог цього висновку, чинного і санітарних норм та правил

якої санітарно-епідеміологічної експертизи Політики, стелажі, сітки, тримачі, підвіски, корзинки, гачки, решітки, тримачі, вставки, вешалки (сталь, алюміній хромований), за яким відомий виробник цього санітарного знаменства України і за умови його висновку: може бути використаний в зазначеній сфері застосування.

згідно рекомендацій виробника.

не, використаний тільки з інструкцією виробника. Висновок не може бути використаний в якості вартості або продукції.

з 12 лютого 2015 р.

підписав вимоги цього висновку після запису.

вимоги: виготовлення, які мають знати власності об'єкта експертизи або її вплив на здоров'я людей, сфери застосування, умов застосування об'єкта експертизи.

TSEK

TÜRK STANDARDLARI ENSTİTÜSÜ
KRITERE UYGUNLUK BELGESİ

TURKISH STANDARDS INSTITUTION
CERTIFICATE OF CONFORMANCE TO CRITERIA

Markanın Tanımı	Description of the Mark
TSEK 994/11-10454	
BELGE NUMARASI REFERENCE NUMBER OF LICENCE	070514-TSEK-0501
BELGENİN İLK VERİLEŞ TARİHİ DATE OF FIRST ISSUE OF LICENCE	27.09.2009
BELGENİN SON GEÇERLİLİK TARİHİ LICENCE VALID UNTIL	27.09.2019
BELGE SAHİBİ KURULUŞUN ADI NAME OF THE LICENCE HOLDER	DOMODEK METAL PLASTIK MAKINA SAN. VE TIC. LTD. ŞTI
BELGE SAHİBİ KURULUŞUN ADRESİ ADDRESS OF THE LICENCE HOLDER	ANKIZCA SANAYİ SİTESİ SOKAK NO: 346/1 ORGANİZE SANAYİ BÖLGESİ KEMALPAŞA - İZMİR / İZMİR
ÜRETİM YERİ ADI NAME OF THE MANUFACTURING PLACE	DOMODEK METAL PLASTIK MAKINA SAN. VE TIC. LTD. ŞTI
ÜRETİM YERİ ADRESİ ADDRESS OF THE MANUFACTURING PLACE	ANKIZCA SANAYİ SİTESİ SOKAK NO: 346/1 ORGANİZE SANAYİ BÖLGESİ KEMALPAŞA - İZMİR / İZMİR
TİSİCİLİ TİCARİ MARKASI REGISTERED TRADE MARK	DOMODEK
İLGİLİ BELGELENDİRME KODU RELATED TYPON STANDARD	TRM-00-5K-000 / Kriteri Belgelendirme Sertifikasyonu / 19/1 / 24.05.2010
BELGE KAPSAMI SCOPE OF LICENCE	

NUTRAC DOLAR İÇİ RNF (KILER) SİSTEMLERİ VE AKOBUANLARI DOLAR İÇİ VEYA AKMA SİSTEMİ BİRDEN KAÇU.

2015
AHMET NAVLI
İZMİR BELGELENDİRME MÜDÜRÜ

1. Bu belge Türkiye'deki diğer bütün kuruluşların katılımıyla gerçekleştirilmiştir ve geçerlidir.
2. Bu belge sadece Türkiye'de geçerlidir ve diğer ülkelerde geçerli değildir.
3. Bu belge, Türkiye'de geçerlidir ve diğer ülkelerde geçerli değildir.
4. Bu belge, Türkiye'de geçerlidir ve diğer ülkelerde geçerli değildir.
5. Bu belge, Türkiye'de geçerlidir ve diğer ülkelerde geçerli değildir.
6. Bu belge, Türkiye'de geçerlidir ve diğer ülkelerde geçerli değildir.
7. Bu belge, Türkiye'de geçerlidir ve diğer ülkelerde geçerli değildir.
8. Bu belge, Türkiye'de geçerlidir ve diğer ülkelerde geçerli değildir.
9. Bu belge, Türkiye'de geçerlidir ve diğer ülkelerde geçerli değildir.
10. Bu belge, Türkiye'de geçerlidir ve diğer ülkelerde geçerli değildir.

Notlar / Notes

- Baskıda oluşacak tipografik hatalardan firmamız sorumlu tutulamaz.
 - Hammade ile ilgili maliyet artışları fiyatlara yansıtılacaktır.
 - Bu katalog içeriği ve görselleri, izin alınmaksızın çoğaltılamaz ve başka yerde kullanılamaz.
- “Firmamız ürün tasarımlarında ve görsellerinde değişiklik yapma hakkını saklı tutar. Sevk edilen ürünlerde katalogdaki referans resimler değil, güncel tasarımlar göz önünde bulundurulur.”

DOMODEK®



Metal mutfak aksesuarları kiler, banyo, gardrop ve bar sistemleri
Metal kitchen accessories pantry, bathroom, wardrop and bar systems

Fabrika (Factory):

Adres (Address): Kemalpaşa O.S.B. Ansızca San. Sit. Sk. No: 346/A 35170 Kemalpaşa
İZMİR TURKEY

Tel: +90 232 878 00 15 – Fax: +90 232 878 61 74

Web: www.domodek.com

E-mail: bilgi@domodek.com



0536 353 02 02

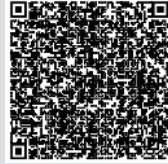

Made in Turkey

TSEK





Smyrna

metale işlenen sanat



ürün katalođu



kod: A-101



10 x 20 D

Boy / length	128	160	192	224	256	288	320
krom / chrome							
inox / inox							
kutu / box	50	50	50	50	50	50	50
koli / package	300	300	300	300	300	300	300

kod: A-102



10 x 20 D

Boy / length	128	160	192	224	256	288	320
krom / chrome							
inox / inox							
kutu / box	50	50	50	50	50	50	50
koli / package	300	300	300	300	300	300	300

kod: A-103



10 x 20 D

Boy / length	128	160	192	224	256	288	320
krom / chrome							
inox / inox							
kutu / box	50	50	50	50	50	50	50
koli / package	300	300	300	300	300	300	300

kod: A-104



10 x 20 D

Boy / length	128	160	192	224	256	288	320
krom / chrome							
inox / inox							
kutu / box	50	50	50	50	50	50	50
koli / package	300	300	300	300	300	300	300

kod: A-105



10 x 20 D

Boy / length	128	160	192	224	256	288	320
krom / chrome							
inox / inox							
kutu / box	50	50	50	50	50	50	50
koli / package	300	300	300	300	300	300	300

kod: A-106



10 x 20 D

Boy / length	128	160	192	224	256	288	320
krom / chrome							
inox / inox							
kutu / box	50	50	50	50	50	50	50
koli / package	300	300	300	300	300	300	300

kod: A-107



10 x 20 D

Boy / length	160-192	224-256
krom / chrome		
inox / inox		
kutu / box	50	50
koli / package	300	300

kod: A-108



10 x 20 D

Boy / length	128	160	192	224	256	288	320
krom / chrome							
inox / inox							
kutu / box	50	50	50	50	50	50	50
koli / package	300	300	300	300	300	300	300

kod: A-201



8 x 19 D

Boy / length	128	160	192	224	256	288	320
krom / chrome							
inox / inox							
kutu / box	50	50	50	50	50	50	50
koli / package	300	300	300	300	300	300	300

kod: A-202



8 x 19 D

Boy / length	128	160	192	224	256	288	320
krom / chrome							
inox / inox							
kutu / box	50	50	50	50	50	50	50
koli / package	300	300	300	300	300	300	300

kod: A-203



8 x 19 D

Boy / length	128	160	192	224	256	288	320
krom / chrome							
inox / inox							
kutu / box	50	50	50	50	50	50	50
koli / package	300	300	300	300	300	300	300

kod: A-204



8 x 19 D

Boy / length	128	160	192	224	256	288	320
krom / chrome							
inox / inox							
kutu / box	50	50	50	50	50	50	50
koli / package	300	300	300	300	300	300	300

kod: A-301

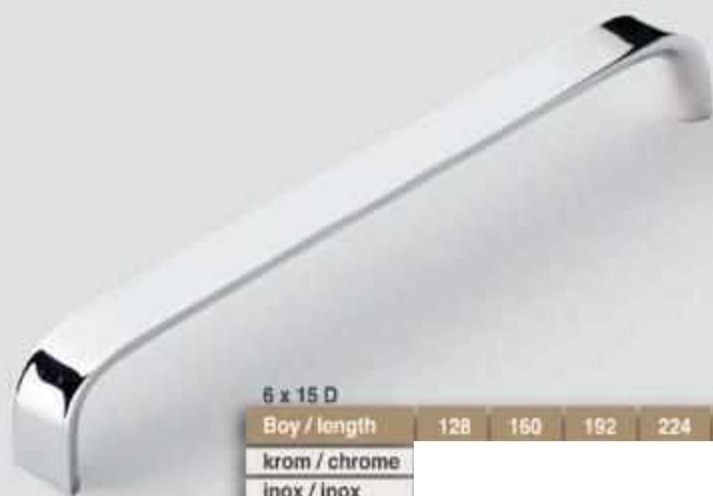

6 x 15 D

Boy / length	128	160	192	224	256	288	320
krom / chrome							
inox / inox							
kutu / box	50	50	50	50	50	50	50
koli / package	300	300	300	300	300	300	300

kod: A-302



6 x 15 D

Boy / length	128	160	192	224	256	288	320
krom / chrome							
inox / inox							
kutu / box	50	50	50	50	50	50	50
koli / package	300	300	300	300	300	300	300

kod: A-303



6 x 15 D

Boy / length	128	160	192	224	256	288	320
krom / chrome							
inox / inox							
kutu / box	50	50	50	50	50	50	50
koli / package	300	300	300	300	300	300	300

kod: A-304



6 x 15 D

Boy / length	128	160	192	224	256	288	320
krom / chrome							
inox / inox							
kutu / box	50	50	50	50	50	50	50
koli / package	300	300	300	300	300	300	300

kod: B-111



7 x 17

Boy / length	128	160	192	224	256	288	320
krom / chrome							
inox / inox							
kutu / box	50	50	50	50	50	50	50
koli / package	300	300	300	300	300	300	300

kod: B-112



7 x 17

Boy / length	128	160	192	224	256	288	320
krom / chrome							
inox / inox							
kutu / box	50	50	50	50	50	50	50
koli / package	300	300	300	300	300	300	300

kod: B-113



7 x 17

Boy / length	128	160	192	224	256	288	320
krom / chrome							
inox / inox							
kutu / box	50	50	50	50	50	50	50
koli / package	300	300	300	300	300	300	300

kod: B-114



7 x 17

Boy / length	128	160	192	224	256	288	320
krom / chrome							
inox / inox							
kutu / box	50	50	50	50	50	50	50
koli / package	300	300	300	300	300	300	300

kod: B-115



7 x 17

Boy / length	128	160	192	224	256	288	320
krom / chrome							
inox / inox							
kutu / box	50	50	50	50	50	50	50
koli / package	300	300	300	300	300	300	300

kod: B-116



7 x 17

Boy / length	128	160	192	224	256	288	320
krom / chrome							
inox / inox							
kutu / box	50	50	50	50	50	50	50
koli / package	300	300	300	300	300	300	300

kod: B-117



7 x 17

Boy / length	128	160	192	224	256	288	320
krom / chrome							
inox / inox							
kutu / box	50	50	50	50	50	50	50
koli / package	300	300	300	300	300	300	300

kod: B-118

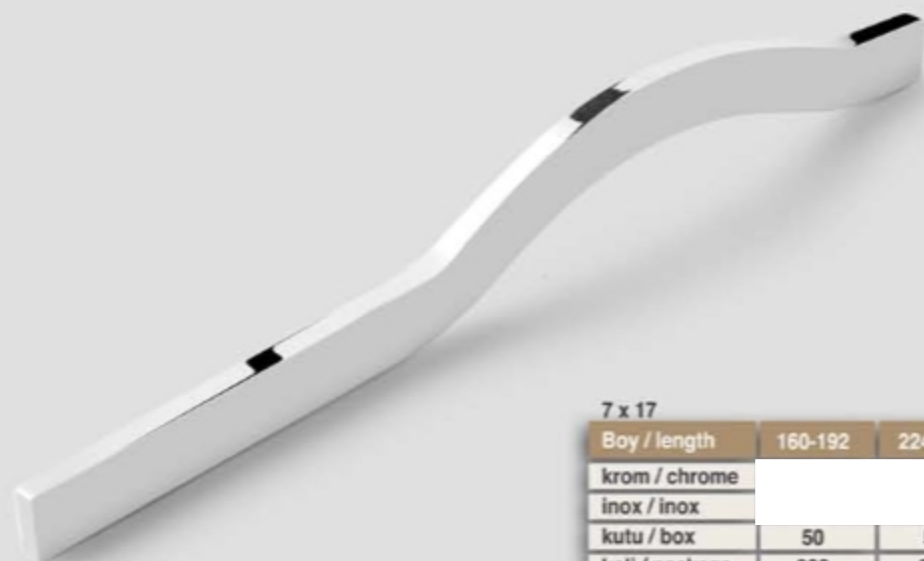

7 x 17

Boy / length	160-192	224-256
krom / chrome		
inox / inox		
kutu / box	50	50
koli / package	300	300

kod: C-121



6.5 x 18

Boy / length	128	160	192	224	256	288	320
krom / chrome							
inox / inox							
kutu / box	50	50	50	50	50	50	50
koli / package	300	300	300	300	300	300	300

kod: C-122



6.5 x 18

Boy / length	128	160	192	224	256	288	320
krom / chrome							
inox / inox							
kutu / box	50	50	50	50	50	50	50
koli / package	300	300	300	300	300	300	300

kod: D-131



8 x 16

Boy / length	128	160	192	224	256	288	320
krom / chrome							
inox / inox							
kutu / box	50	50	50	50	50	50	50
koli / package	300	300	300	300	300	300	300

kod: D-132



8 x 16

Boy / length	128	160	192	224	256	288	320
krom / chrome							
inox / inox							
kutu / box	50	50	50	50	50	50	50
koli / package	300	300	300	300	300	300	300

kod: D-133



8 x 16

Boy / length	128	160	192	224	256	288	320
krom / chrome							
inox / inox							
kutu / box	50	50	50	50	50	50	50
koli / package	300	300	300	300	300	300	300

kod: E-141



10 x 12

Boy / length	128	160	192	224	256	288	320
krom / chrome							
inox / inox							
kutu / box	50	50	50	50	50	50	50
koli / package	300	300	300	300	300	300	300

kod: E-142



10 x 12

Boy / length	128	160	192	224	256	288	320
krom / chrome							
inox / inox							
kutu / box	50	50	50	50	50	50	50
koli / package	300	300	300	300	300	300	300

kod: E-143

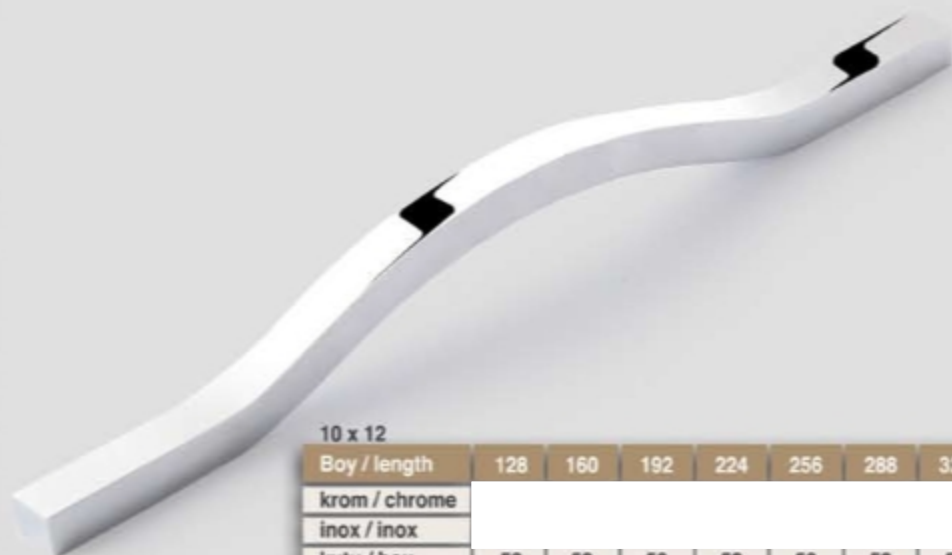

10 x 12

Boy / length	128	160	192	224	256	288	320
krom / chrome							
inox / inox							
kutu / box	50	50	50	50	50	50	50
koli / package	300	300	300	300	300	300	300

kod: E-144



10 x 12

Boy / length	160-192	224-256
krom / chrome		
inox / inox		
kutu / box	50	50
koli / package	300	300

kod: F-151



8 x 25

Boy / length	128	160	192	224	256	288	320
krom / chrome							
inox / inox							
kutu / box	40	40	40	40	40	40	40
koli / package	240	240	240	240	240	240	240

kod: F-152



8 x 25

Boy / length	128	160	192	224	256	288	320
krom / chrome							
inox / inox							
kutu / box	40	40	40	40	40	40	40
koli / package	240	240	240	240	240	240	240

kod: F-153



8 x 25

Boy / length	128	160	192	224	256	288	320
krom / chrome							
inox / inox							
kutu / box	40	40	40	40	40	40	40
koli / package	240	240	240	240	240	240	240

kod: F-154



8 x 25

Boy / length	128	160	192	224	256	288	320
krom / chrome							
inox / inox							
kutu / box	40	40	40	40	40	40	40
koli / package	240	240	240	240	240	240	240

kod: G-161



10 x 17

Boy / length	128	160	192	224	256	288	320
krom / chrome							
inox / inox							
kutu / box	50	50	50	50	50	50	50
koli / package	300	300	300	300	300	300	300

kod: G-162



10 x 17

Boy / length	128	160	192	224	256	288	320
krom / chrome							
inox / inox							
kutu / box	50	50	50	50	50	50	50
koli / package	300	300	300	300	300	300	300

kod: G-163



10 x 17

Boy / length	128	160	192	224	256	288	320
krom / chrome							
inox / inox							
kutu / box	50	50	50	50	50	50	50
koli / package	300	300	300	300	300	300	300

kod: H-171



L profil

Boy / length	128	160	192	224	256	288	320
krom / chrome							
inox / inox							
kutu / box	50	50	50	50	50	50	50
koli / package	300	300	300	300	300	300	300

kod: H-172



L Profil

Boy / length	32	64	96
krom / chrome			
inox / inox			
kutu / box	50	50	50
koli / package	300	300	300

kod: K-191



Ø : 12

Boy / length	128	160	192	224	256	288	320
krom / chrome							
inox / inox							
kutu / box	50	50	50	50	50	50	50
koli / package	300	300	300	300	300	300	300

kod: K-192



Ø : 12

Boy / length	128	160	192	224	256	288	320
krom / chrome							
inox / inox							
kutu / box	50	50	50	50	50	50	50
koli / package	300	300	300	300	300	300	300



Made in Turkey

Fabrika (Factory):

Adres (Address): Kernalsapa O.S.B. Anızcı San. Sit. Sk. No: 346/A 35170 Kernalsapa
İZMİR TURKEY

Tel: +90 232 878 00 15 - Fax +90 232 878 61 74

Web: www.gomodek.com

E-mail: bilgi@gomodek.com