

DOMODEK®



Metal mutfak aksesuarları kiler, banyo, gardrop ve bar sistemleri
Metal kitchen accessories pantry, bathroom, wardrop and bar systems



2020 / 1 ÜRÜN KATALOĞU / PRODUCTS CATALOG

Teleskopik kiler grubu / Telescopic pantry group

Standart Sepet / Standart Basket

Ürün Kodu / Product Code	Ürün Adı / Product Name	Sepet / Basket	Ölçüler / Size GxDxY / WxDxH (mm)	Modül / Modul (mm)	Hacim / Volume (m3)	Ağırlık / Weight (kg)
966030	60 - 80 cm	2	230 x 500 x 600 - 800	300	0,07	9,60
966035	60 - 80 cm	2	280 x 500 x 600 - 800	350	0,07	9,99
966040	60 - 80 cm	2	330 x 500 x 600 - 800	400	0,07	10,38
966045	60 - 80 cm	2	380 x 500 x 600 - 800	450	0,07	10,75
966050	60 - 80 cm	2	430 x 500 x 600 - 800	500	0,07	11,11
968530	85 - 110 cm	3	230 x 500 x 850 - 1100	300	0,12	11,08
968535	85 - 110 cm	3	280 x 500 x 850 - 1100	350	0,12	11,60
968540	85 - 110 cm	3	330 x 500 x 850 - 1100	400	0,12	12,14
968545	85 - 110 cm	3	380 x 500 x 850 - 1100	450	0,12	12,70
968550	85 - 110 cm	3	430 x 500 x 850 - 1100	500	0,12	13,23
961130	110 - 125 cm	4	230 x 500 x 1100 - 1250	300	0,13	12,47
961135	110 - 125 cm	4	280 x 500 x 1100 - 1250	350	0,13	13,12
961140	110 - 125 cm	4	330 x 500 x 1100 - 1250	400	0,13	13,80
961145	110 - 125 cm	4	380 x 500 x 1100 - 1250	450	0,13	14,59
961150	110 - 125 cm	4	430 x 500 x 1100 - 1250	500	0,13	15,22
961230	125 - 140 cm	4	230 x 500 x 1250 - 1400	300	0,15	12,80
961235	125 - 140 cm	4	280 x 500 x 1250 - 1400	350	0,15	13,45
961240	125 - 140 cm	4	330 x 500 x 1250 - 1400	400	0,15	14,16
961245	125 - 140 cm	4	380 x 500 x 1250 - 1400	450	0,15	14,92
961250	125 - 140 cm	4	430 x 500 x 1250 - 1400	500	0,15	15,54
961430	140 - 155 cm	5	230 x 500 x 1400 - 1550	300	0,17	14,06
961435	140 - 155 cm	5	280 x 500 x 1400 - 1550	350	0,17	14,85
961440	140 - 155 cm	5	330 x 500 x 1400 - 1550	400	0,17	15,72
961445	140 - 155 cm	5	380 x 500 x 1400 - 1550	450	0,17	16,70
961450	140 - 155 cm	5	430 x 500 x 1400 - 1550	500	0,17	17,46
961530	155 - 170 cm	5	230 x 500 x 1550 - 1700	300	0,18	14,23
961535	155 - 170 cm	5	280 x 500 x 1550 - 1700	350	0,18	15,02
961540	155 - 170 cm	5	330 x 500 x 1550 - 1700	400	0,18	15,86
961545	155 - 170 cm	5	380 x 500 x 1550 - 1700	450	0,18	16,87
961550	155 - 170 cm	5	430 x 500 x 1550 - 1700	500	0,18	17,63
961730	170 - 185 cm	6	230 x 500 x 1700 - 1850	300	0,20	15,95
961735	170 - 185 cm	6	280 x 500 x 1700 - 1850	350	0,20	16,88
961740	170 - 185 cm	6	330 x 500 x 1700 - 1850	400	0,20	17,96
961745	170 - 185 cm	6	380 x 500 x 1700 - 1850	450	0,20	19,22
961750	170 - 185 cm	6	430 x 500 x 1700 - 1850	500	0,20	20,09
961830	185 - 200 cm	6	230 x 500 x 1850 - 2000	300	0,22	16,13
961835	185 - 200 cm	6	280 x 500 x 1850 - 2000	350	0,22	17,06
961840	185 - 200 cm	6	330 x 500 x 1850 - 2000	400	0,22	18,14
961845	185 - 200 cm	6	380 x 500 x 1850 - 2000	450	0,22	19,40
961850	185 - 200 cm	6	430 x 500 x 1850 - 2000	500	0,22	20,27
962030	200 - 215 cm	7	230 x 500 x 2000 - 2150	300	0,23	17,43
962035	200 - 215 cm	7	280 x 500 x 2000 - 2150	350	0,23	18,49
962040	200 - 215 cm	7	330 x 500 x 2000 - 2150	400	0,23	19,73
962045	200 - 215 cm	7	380 x 500 x 2000 - 2150	450	0,23	21,18
962050	200 - 215 cm	7	430 x 500 x 2000 - 2150	500	0,23	22,25

TEK SEPET / SINGLE BASKET

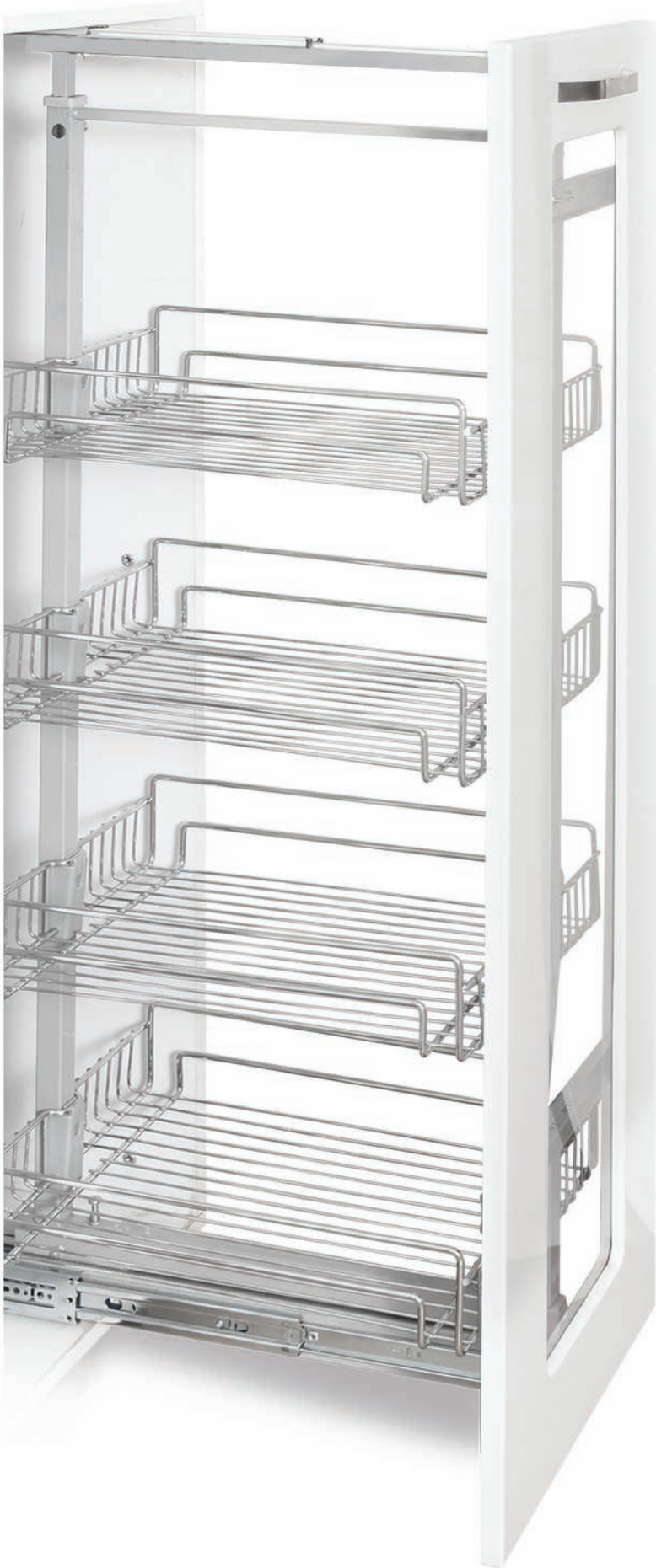

- Alt ve üst mekanizmalarda bilyeli teleskopik ray kullanılmıştır.
- Taşıma kapasitesi sepet başı maksimum 15kg' dır.
- Gövde uzunluğu, modül yüksekliğine uygun ayarlanabilir.
- Sepetler 5 farklı ölçüsü ile modül genişliğine uygundur.
- Alt ve üst mekanizmalar ve gövde gri boyalı, sepetler krom kaplamalıdır.

- Ball bearing telescopic rails are used in the bottom and top mechanisms.
- Carrying capacity is max. 15kg for each basket.
- Body length can be adjusted according to the height of the module.
- Five different size of baskets are appropriate to the width of the module.
- Bottom and top mechanisms and body are painted grey, baskets are chrome plated.



Frenli kiler grubu / Soft close pantry group

SOFT CLOSE (Frenli)

Frenli kiler grubu / Soft close pantry units

Standart Sepet / Standard Basket

Ürün Kodu / Product Code	Ürün Adı / Product Name	Sepet / Basket	Ölçüler / Size GxDxY / WxDxH (mm)	Modül / Modul (mm)	Hacim / Volume (m3)	Ağırlık / Weight (kg)
976030	60 - 80 cm	2	230 x 500 x 600 - 800	300	0,07	15,60
976035	60 - 80 cm	2	280 x 500 x 600 - 800	350	0,07	15,99
976040	60 - 80 cm	2	330 x 500 x 600 - 800	400	0,07	16,38
976045	60 - 80 cm	2	380 x 500 x 600 - 800	450	0,07	16,75
976050	60 - 80 cm	2	430 x 500 x 600 - 800	500	0,07	17,11
978530	85 - 110 cm	3	230 x 500 x 850 - 1100	300	0,12	17,08
978535	85 - 110 cm	3	280 x 500 x 850 - 1100	350	0,12	17,60
978540	85 - 110 cm	3	330 x 500 x 850 - 1100	400	0,12	18,14
978545	85 - 110 cm	3	380 x 500 x 850 - 1100	450	0,12	18,70
978550	85 - 110 cm	3	430 x 500 x 850 - 1100	500	0,12	19,23
971130	110 - 125 cm	4	230 x 500 x 1100 - 1250	300	0,13	18,47
971135	110 - 125 cm	4	280 x 500 x 1100 - 1250	350	0,13	19,12
971140	110 - 125 cm	4	330 x 500 x 1100 - 1250	400	0,13	19,80
971145	110 - 125 cm	4	380 x 500 x 1100 - 1250	450	0,13	20,59
971150	110 - 125 cm	4	430 x 500 x 1100 - 1250	500	0,13	21,22
971230	125 - 140 cm	4	230 x 500 x 1250 - 1400	300	0,15	18,80
971235	125 - 140 cm	4	280 x 500 x 1250 - 1400	350	0,15	19,45
971240	125 - 140 cm	4	330 x 500 x 1250 - 1400	400	0,15	20,16
971245	125 - 140 cm	4	380 x 500 x 1250 - 1400	450	0,15	20,92
971250	125 - 140 cm	4	430 x 500 x 1250 - 1400	500	0,15	21,54
971430	140 - 155 cm	5	230 x 500 x 1400 - 1550	300	0,17	20,06
971435	140 - 155 cm	5	280 x 500 x 1400 - 1550	350	0,17	20,85
971440	140 - 155 cm	5	330 x 500 x 1400 - 1550	400	0,17	21,72
971445	140 - 155 cm	5	380 x 500 x 1400 - 1550	450	0,17	22,70
971450	140 - 155 cm	5	430 x 500 x 1400 - 1550	500	0,17	23,46
971530	155 - 170 cm	5	230 x 500 x 1550 - 1700	300	0,18	20,23
971535	155 - 170 cm	5	280 x 500 x 1550 - 1700	350	0,18	21,02
971540	155 - 170 cm	5	330 x 500 x 1550 - 1700	400	0,18	21,88
971545	155 - 170 cm	5	380 x 500 x 1550 - 1700	450	0,18	22,87
971550	155 - 170 cm	5	430 x 500 x 1550 - 1700	500	0,18	23,63
971730	170 - 185 cm	6	230 x 500 x 1700 - 1850	300	0,20	21,95
971735	170 - 185 cm	6	280 x 500 x 1700 - 1850	350	0,20	22,68
971740	170 - 185 cm	6	330 x 500 x 1700 - 1850	400	0,20	23,96
971745	170 - 185 cm	6	380 x 500 x 1700 - 1850	450	0,20	25,22
971750	170 - 185 cm	6	430 x 500 x 1700 - 1850	500	0,20	26,09
971830	185 - 200 cm	6	230 x 500 x 1850 - 2000	300	0,22	22,13
971835	185 - 200 cm	6	280 x 500 x 1850 - 2000	350	0,22	23,06
971840	185 - 200 cm	6	330 x 500 x 1850 - 2000	400	0,22	24,14
971845	185 - 200 cm	6	380 x 500 x 1850 - 2000	450	0,22	25,40
971850	185 - 200 cm	6	430 x 500 x 1850 - 2000	500	0,22	26,27
972030	200 - 215 cm	7	230 x 500 x 2000 - 2150	300	0,23	23,43
972035	200 - 215 cm	7	280 x 500 x 2000 - 2150	350	0,23	24,49
972040	200 - 215 cm	7	330 x 500 x 2000 - 2150	400	0,23	25,73
972045	200 - 215 cm	7	380 x 500 x 2000 - 2150	450	0,23	27,18
972050	200 - 215 cm	7	430 x 500 x 2000 - 2150	500	0,23	28,25

TEK SEPET / SINGLE BASKET

SSSSSOFT CLOSE (Frenli)

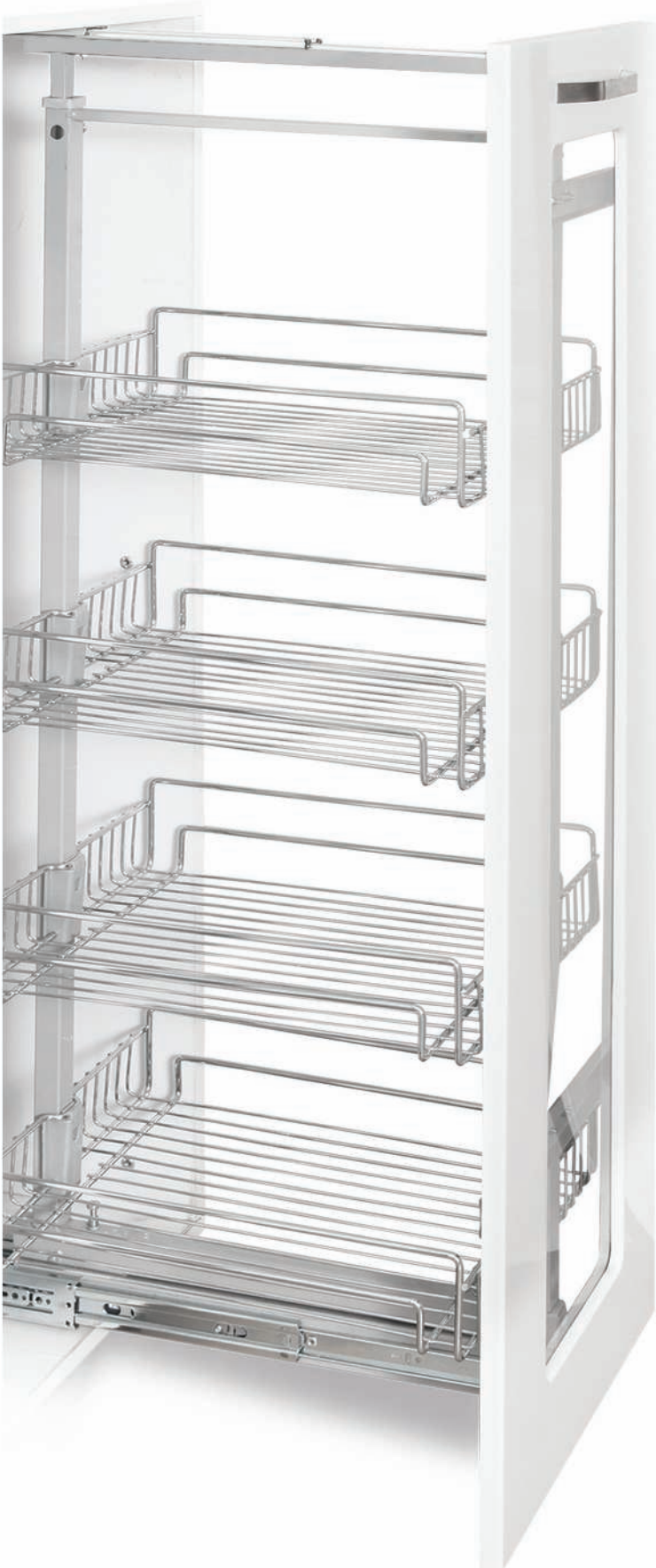

2 years
guarantee

Ahşap tabanlı lüks frenli kiler grubu / Wooden based lux soft close pantry group



- Sepet tabanları 18mm MDFLAM' dir.
- Taşıma kapasitesi maksimum 50 kg' dir.
- Gövde uzunluğu, kabin yüksekliğine uygun olarak ayarlanabilir.
- Sepetler 7 farklı ölçüsü ile istediğiniz modül genişliğine uygundur.
- İster menteşeli kapakla ister ürüne monte kapakla kullanılabilir

- *Basket floors are made of 18mm MDF.*
- *Carrying capacity is 50 kg.*
- *Height of the body can be adjusted according to the height of the cabinet.*
- *Sevendifferent size of baskets are appropriate to the width of the modüle.*
- *Available hinged cabinets with door or mounted module covers.*



Ahşap tabanlı lüks frenli kiler grubu / Wooden based lux soft close pantry group

Ürün Kodu / Product Code	Sepet / Basket	Ölçüler / Size GxDxY / WxDxH (mm)	Modül / Modul (mm)	Hacim / Volume (m3)	Ağırlık / Weight (kg)
92916	2	150 x 500 x 700 - 850	200	0,09	12,00
92917	2	200 x 500 x 700 - 850	250	0,09	12,50
92911	2	250 x 500 x 700 - 850	300	0,09	12,90
92912	2	300 x 500 x 700 - 850	350	0,09	13,50
92913	2	350 x 500 x 700 - 850	400	0,09	14,10
92914	2	400 x 500 x 700 - 850	450	0,09	14,70
92915	2	450 x 500 x 700 - 850	500	0,09	15,30
92926	3	150 x 500 x 850 - 1100	200	0,12	14,50
92927	3	200 x 500 x 850 - 1100	250	0,12	15,30
92921	3	250 x 500 x 850 - 1100	300	0,12	15,80
92922	3	300 x 500 x 850 - 1100	350	0,12	16,40
92923	3	350 x 500 x 850 - 1100	400	0,12	17,00
92924	3	400 x 500 x 850 - 1100	450	0,12	17,60
92925	3	450 x 500 x 850 - 1100	500	0,12	18,20
92936	4	150 x 500 x 1250 - 1400	200	0,14	19,00
92937	4	200 x 500 x 1250 - 1400	250	0,14	19,50
92931	4	250 x 500 x 1250 - 1400	300	0,14	20,00
92932	4	300 x 500 x 1250 - 1400	350	0,14	20,60
92933	4	350 x 500 x 1250 - 1400	400	0,14	21,20
92934	4	400 x 500 x 1250 - 1400	450	0,14	21,80
92935	4	450 x 500 x 1250 - 1400	500	0,14	22,40
92946	5	150 x 500 x 1550 - 1700	200	0,17	23,00
92947	5	200 x 500 x 1550 - 1700	250	0,17	23,50
92941	5	250 x 500 x 1550 - 1700	300	0,17	23,90
92942	5	300 x 500 x 1550 - 1700	350	0,17	24,50
92943	5	350 x 500 x 1550 - 1700	400	0,17	25,10
92944	5	400 x 500 x 1550 - 1700	450	0,17	25,70
92945	5	450 x 500 x 1550 - 1700	500	0,17	26,30
92956	6	150 x 500 x 1850 - 2000	200	0,21	33,00
92957	6	200 x 500 x 1850 - 2000	250	0,21	33,80
92951	6	250 x 500 x 1850 - 2000	300	0,21	34,2
92952	6	300 x 500 x 1850 - 2000	350	0,21	36,5
92953	6	350 x 500 x 1850 - 2000	400	0,21	38,5
92954	6	400 x 500 x 1850 - 2000	450	0,21	40,5
92955	6	450 x 500 x 1850 - 2000	500	0,21	42,5
92966	7	150 x 500 x 2000 - 2150	200	0,25	45,50
92967	7	200 x 500 x 2000 - 2150	250	0,25	46,00
92961	7	250 x 500 x 2000 - 2150	300	0,25	46,5
92962	7	300 x 500 x 2000 - 2150	350	0,25	48,5
92963	7	350 x 500 x 2000 - 2150	400	0,25	50,5
92964	7	400 x 500 x 2000 - 2150	450	0,25	52,5
92965	7	450 x 500 x 2000 - 2150	500	0,25	54,5

İkiz kiler grubu / Twince pantry units

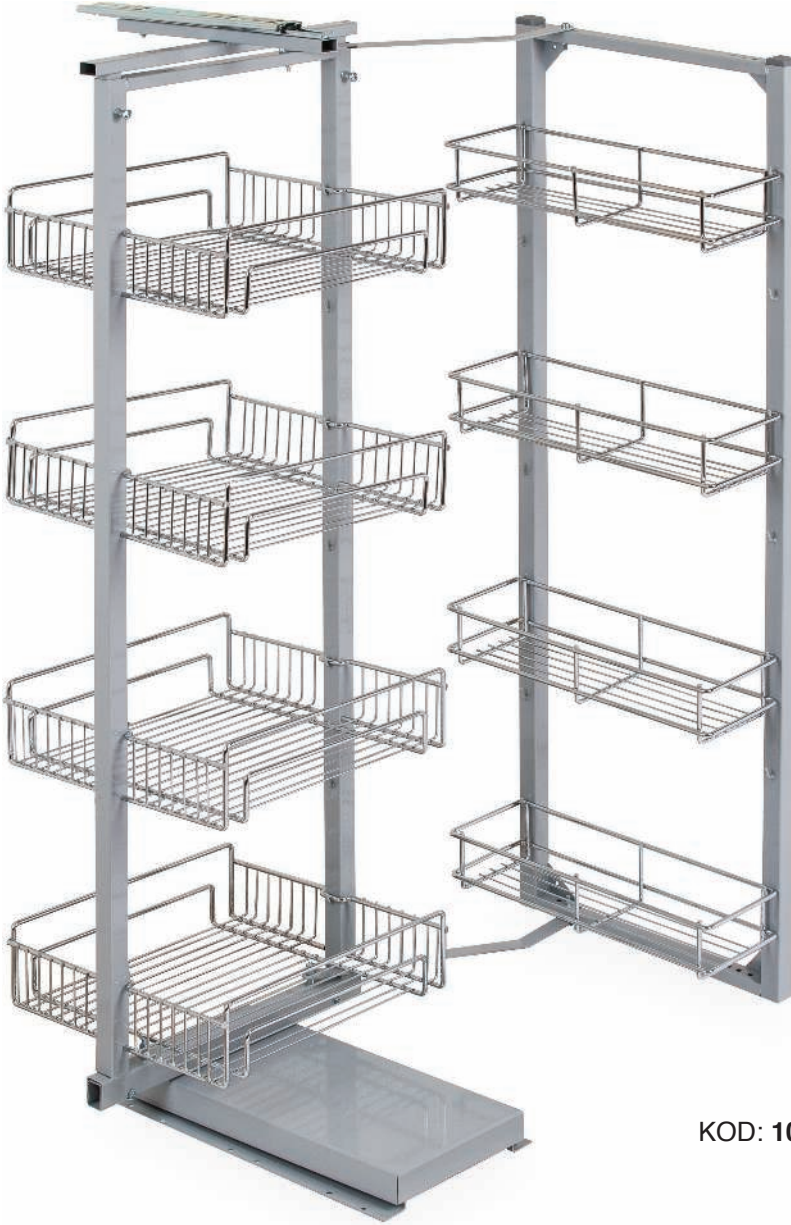

KOD: 10205

- Alt ve üst mekanizmalarda bilyeli teleskopik ray kullanılmıştır.
- Taşıma kapasitesi; arka mekanizma için maksimum 60kg, kapak mekanizması için maksimum 20kg dir.
- Menteşeli kapaklı tezgahaltı ya da üst dolaplarda kullanılabilir..
- 2 farklı modülde sağ ve sol yöne kullanılır.
- Kapak açıldığında arka gövde öne gelir, sepet içine kolay erişim sağlanır.
- Sepetler istenilen aralıklı yerleştirilebilir.
- Taşıyıcı mekanizma ve gövde gri boyalı, sepetler krom kaplamalıdır.

- Ball bearing telescopic rails are used in the bottom and top mechanisms.
- Carrying Capacity is max. 60 kg for back mechanism, and max 20 kg for door mechanism.
- Available for hinged under-counter or top cabinets with door.
- Can be used to open right or left with 2 different modules.
- When the door is open, back mechanism comes to front, provides easy access to the baskets.
- Baskets used on body by installing with desired distances onto channels of the profile.
- Bottom, top and door mechanisms are painted grey, baskets are chrome plated.

Bergama ikiz kiler / Bergamon twince pantry

Ürün Kodu / Product Code	Tip / Type	Ölçüler / Size GxDxY / WxDxH (mm)	Modül / Modul (mm)	Hacim / Volume (m3)	Ağırlık / Weight (kg)
10105	125'lik	500 x 500 x 1250 - 1400	60	0,24	20,00
10205	125'lik	350 x 500 x 1250 - 1400	45	0,24	17,80
10116	170'lik	500 x 500 x 1700 - 1850	60	0,30	30,00
10114	170'lik	350 x 500 x 1700 - 1850	45	0,30	25,00

Kör köşe grubu / Secret corner group



- Mutfaklarınızdaki köşe bölgeleri değerlendirmek içindir.
- Menteşeli kapak ile kullanıma uygundur.
- Taşıma kapasitesi, her bir sepet için 20kg' dir.
- Taşıyıcı boru, dolap yüksekliğine uygun ayarlanabilir.
- Sepetler birbirinden bağımsızdır çıkarılabilir.
- Sepet tabanları 18mm MDFLAM' dir.
- Sepet çevresi krom kaplama görünümlüdür.
- Sepet çerçevesi krom kaplamadır.
- Mekanizmalar gri renkte, sepet tabanları beyaz renktedir.

- Can be used to reach corner regions in your kitchen.
- Available hinged door on the corner cabinets.
- Carrying capacity is 20 kg for each basket.
- Carrier pipe can be adjusted according to the cabinet height.
- Both baskets are independent to each other.
- Basket floors are made of 18mm MDF.
- Baskets are surrounded by material looks like chrome plated.
- Basket frames are chrome plated.
- Mechanisms are grey, basket floors are white.

KOD: 39193 / Sol

Ahşap tabanlı elips kör köşe grubu / Wooden secret corner group

Ürün Kodu / Product Code	Model / Model	Modül / Modul (mm)	Ölçüler / Size GxDxY / WxDxH (mm)	Hacim / Volume (m3)	Ağırlık / Weight (kg)
39192 (frenli&Soft Close)	elips sağ / elips (right)	45	900 x 530 x 750	0,08	13,00
39193 (frenli&Soft Close)	elips sol / elips (left)	45	900 x 530 x 750	0,08	13,00
39392 (frenli&Soft Close) (ANTRASİT)	elips sağ / elips (right)	45	900 x 530 x 750	0,08	13,00
39393 (frenli&Soft Close) (ANTRASİT)	elips sol / elips (left)	45	900 x 530 x 750	0,08	13,00

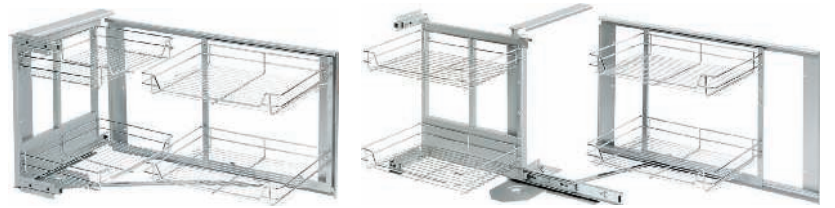
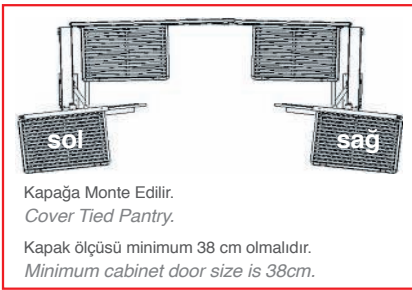

KOD: 39196

- Taşıma kapasitesi kapak mekanizması için 15 kg, arka mekanizma için 20 kg dir.
- Sepetler istenen aralıklarla asılarak kullanılır.
- Modül kapağının açılmasıyla ön taşıyıcıdaki sepetler dışarı çıkar, aynı anda arka taşıyıcı üzerindeki sepetler hareket ederek kolay ulaşılabilir pozisyonu alır.

SOFT CLOSE (Frenli)

- Carrying capacity for door mechanism is 20 kg, for back mechanism 30 kg.
- Baskets can be installed with desired distances.
- When you open module door; baskets on the front carrier come out at the same time baskets on the behind carrier move and have easily accessible position.

Kapağa monte kör köşe grubu / Secret corner group

Ürün Kodu / Product Code	Model / Model	Modül / Modul (mm)	Ölçüler / Size GxDxY / WxDxH (mm)	Hacim / Volume (m3)	Ağırlık / Weight (kg)
39195	sağ / (right) frenli/soft close	40	860 x 530 x 600	0,15	20,20
39196	sol / (left) frenli/soft close	40	860 x 530 x 600	0,15	20,20

Döner köşe grubu / Revolving corner group

- Menteşeli iki kapak ile kullanıma uygundur.
 - Taşıma kapasitesi, her sepet için 20 kg dır.
 - Alt sepet, taşıyıcı boru üzerinde tabanda, üst sepet ortada sabitlenerek kullanılır.
 - Taşıyıcı boru üzerinde 360° döndürülen sepetlerin her noktasına ulaşabilmek mümkündür.
 - Taşıyıcı boru, dolap yüksekliğine uygun ayarlanabilir.
 - Mekanizmada sepetler krom kaplamalı, taşıyıcı boru alüminyumdur.
- Available hinged two doors on the corner cabinets.
 - Carrying capacity is 20 kg for each of basket.
 - Bottom basket can be fixed on the carrier pipe at the base, upper basket can be fixed in the middle of the pipe.
 - Possible to reach any point of 360° turning baskets on the carrier pipe.
 - Carrier pipe can be adjusted according to the cabinet height.
 - Baskets are chrome plated, carrier pipe is aluminum.

SOFT STOP
FRENLİ



KOD: 24069



KOD: 23068



KOD: 22099

Döner köşe grubu / Revolving corner group

Ürün Kodu / Product Code	Model / Model	Ölçüler / Size GxDxY / WxDxH (mm)	Hacim / Volume (m3)	Ağırlık / Weight (kg)
24067	4/4 56	560 x 560 x 700 - 750	0,07	5,30
24069	4/4 72	720 x 720 x 700 - 750	0,11	6,30
24203	4/4 82	820 x 820 x 700 - 750	0,15	7,20
23066	3/4 56	560 x 560 x 700 - 750	0,07	5,00
23068	3/4 72	720 x 720 x 700 - 750	0,11	6,00
23201	3/4 82	820 x 820 x 700 - 750	0,15	7,00
22100	1/2 64 (borulu/with tube)	640 x 320 x 700 - 750	0,07	4,50
22099	1/2 74 (borulu/with tube)	740 x 370 x 700 - 750	0,07	5,20

Ahşap tabanlı döner köşe grubu / Wooden based revolving corner group

- Mutfaklarınızdaki köşe bölgeleri değerlendirmek içindir.
- Menteşeli kapak ile kullanıma uygundur.
- Taşıma kapasitesi, her bir sepet için 20kg' dır.
- Taşıyıcı boru, dolap yüksekliğine uygun ayarlanabilir.
- Sepetler birbirinden bağımsızdır çıkarılabilir.
- Sepet tabanları 18mm MDFLAM' dır.
- Sepet çevresi krom kaplama görünümlüdür.
- Sepet çerçevesi krom kaplamadır.
- Mekanizmalar gri renkte, sepet tabanları beyaz renktedir.

- *Can be used to reach corner regions in your kitchen.*
- *Available hinged door on the corner cabinets.*
- *Carrying capacity is 20 kg for each basket.*
- *Carrier pipe can be adjusted according to the cabinet height.*
- *Both baskets are independent to each other.*
- *Basket floors are made of 18mm MDF.*
- *Baskets are surrounded by material looks like chrome plated.*
- *Basket frames are chrome plated.*
- *Mechanisms are grey, basket floors are white.*



KOD: 24962



KOD: 23962



KOD: 22951

Ahşap Tabanlı Döner köşe grubu / Wooden based revolving corner group

Ürün Kodu / Product Code	Model / Model	Ölçüler / Size GxDxY / WxDxH (mm)	Hacim / Volume (m3)	Ağırlık / Weight (kg)
24961	4/4 56	560 x 560 x 700 - 750	0,07	12,70
24962	4/4 72	720 x 720 x 700 - 750	0,12	14,90
23961	3/4 56	560 x 560 x 700 - 750	0,07	11,20
23962	3/4 72	720 x 720 x 700 - 750	0,12	13,20
22950	1/2 64	640 x 320 x 700 - 750	0,07	7,50
22951	1/2 74	740 x 320 x 700 - 750	0,07	9,00

Yandan raylı şişelik-deterjanlık grubu / Bottle-detergent unit side tied

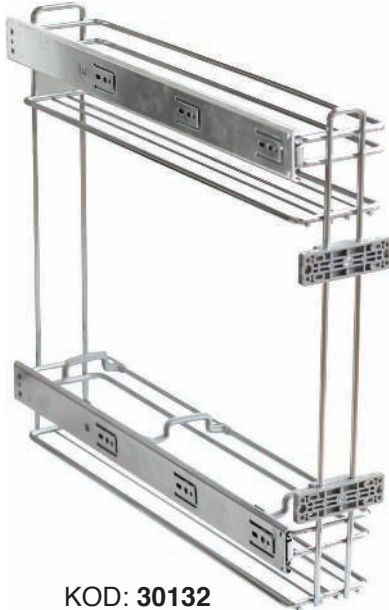

KOD: 30132

- Tezgah altında, menteşeli kapaklı dolaplarda ya da modül kapağına monte edilerek kullanılır.
- Genişliği dar modüllerde maksimum kullanım alanı sağlar.
- Taşıma kapasitesi 15 kg dır.
- İster bilyalı teleskobik rayla ister yavaş ve sessiz kapanma sağlayan soft close teleskobik rayla kullanılabilir.
- Modülün sağ veya sol paneline monte edilebilir.
- Sepet yüzeyleri krom kaplamadır.



KOD: 31133

- Available under-counter hinged cabinets with door or mounted module covers.
- Narrow width of the module provides the maximum use of space.
- Carrying capacity 15 kg.
- Can be used with ball bearing telescopic rails or soft close telescopic rails which provides silent and smooth closing.
- Baskets are chrome plated.

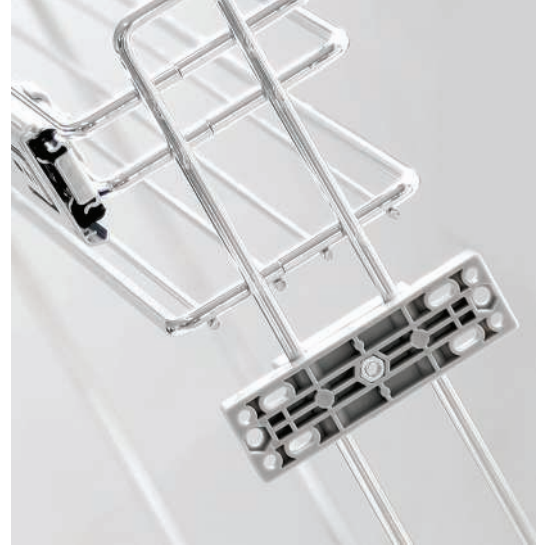

KOD:31133



Yandan raylı şişelik-deterjanlık grubu / Bottle-detergent unit side tied

Ürün Kodu / Product Code	Tip / Type	Ölçüler / Size GxDxY / WxDxH (mm)	Modül / Modul (mm)	Hacim / Volume (m3)	Koli içi Ad. / Volume (m3)	Ağırlık / Weight (kg)
30132	Teleskopik Telescopic	Şişelik / bottle holder	15	0,03	5	4,20
31133		Deterjanlık / detergent place	20	0,04	4	4,50
31135			25	0,06	1	4,80
32134		Dar-geniş / tight-wide	30	0,06	1	5,20
32504		Geniş-geniş / wide-wide	30	0,06	1	5,50
30111	Frenli Soft close	Şişelik / bottle holder	15	0,03	5	4,20
30112		Deterjanlık / detergent place	20	0,04	4	4,50
30115			25	0,06	1	4,80
30113		Frenli / Soft close - Dar-geniş / tight-wide	30	0,06	1	5,20
30114		Frenli / Soft close - Geniş-geniş / wide-wide	30	0,06	1	5,50
31232	Teleskopik Telescopic	Ekonomik / Economic	15	0,04	5	2,60
31234		Ekonomik / Economic	20	0,05	4	2,90
31235		Ekonomik / Economic	25	0,05	1	3,10
31236		Ekonomik / Economic	30	0,06	1	3,20

TSEK

DOMODEK®

Smart slide deterjanlık grubu / Smart slide detergent unit

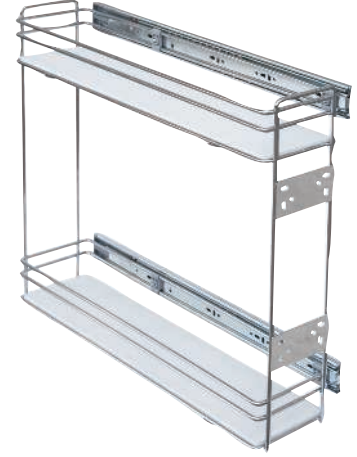

SOFT CLOSE (Frenli)

Tandem Ray & Tandem Slides

- Tezgah altında, menteşeli kapaklı dolaplarda ya da modül kapağına monte edilerek kullanılır.
- Genişliği dar modüllerde maksimum kullanım alanı sağlar.
- Taşıma kapasitesi 15 kg'dır.
- Smart slide teleskobik raylar kullanılmıştır.
- Modülün sağ veya sol paneline monte edilebilir.
- Sepet yüzeyleri krom kaplamadır.

- Available under-counter hinged cabinets with door or mounted module covers.
- Narrow width of the module provides the maximum use of space.
- Carrying capacity 15 kg.
- Smart slide telescopic rails are used.
- Baskets are chrome plated.

Tandem raylı frenli deterjanlık grubu / Tandem soft close detergent unit group

Ürün Kodu / Product Code	Tip / Type	Ölçüler / Size GxDxY / WxDxH (mm)	Modül / Modul (mm)	Hacim / Volume (m3)	Ağırlık / Weight (kg)
31121	çift açılım frenli / full ex.soft close	108 x 500 x 470	150	0,04	4,80
31122	çift açılım frenli / full ex.soft close	136 x 500 x 470	200	0,05	5,00
31123	çift açılım frenli / full ex.soft close	192 x 500 x 470	250	0,06	5,40
31124	çift açılım frenli / full ex.soft close	256 x 500 x 470	300	0,07	5,70
31127	tek açılım frenli / single ex.soft close	106 x 500 x 470	150	0,04	4,20
31128	tek açılım frenli / single ex.soft close	136 x 500 x 470	200	0,05	4,40
31129	tek açılım frenli / single ex.soft close	192 x 500 x 470	250	0,06	4,80
31130	tek açılım frenli / single ex.soft close	256 x 500 x 470	300	0,07	5,10

Ahşap tabanlı frenli deterjanlık grubu / Wooden based soft close detergent unit group

Ahşap tabanlı teleskopik raylı deterjanlık grubu / Wooden based telescopic rails detergent unit

36121	frenli / soft close	116 x 515 x 475	150	0,04	4,60
36122	frenli / soft close	140 x 515 x 475	200	0,05	5,00
36123	frenli / soft close	206 x 515 x 475	300	0,06	5,50

Çekmece grubu / Drawer group



KOD: 63262

- Carrying capacity 15 kg.
- Can be used with ball bearing telescopic rails or soft close telescopic rails which provides silent and smooth closing.
- Baskets with 9 different module sizes are chrome plated.

Teleskopik raylı derin çekmece grubu / Telescopic deep drawer group

Ürün Kodu / Product Code	Tip / Type	Ölçüler / Size GxDxY / WxDxH (mm)	Modül / Modul (mm)	Hacim / Volume (m3)	Ağırlık / Weight (kg)
63260	teleskopik / telescopic	300 x 500 x 180	35	0,04	4,70
63261	teleskopik / telescopic	350 x 500 x 180	40	0,04	5,00
63262	teleskopik / telescopic	400 x 500 x 180	45	0,04	5,30
63263	teleskopik / telescopic	450 x 500 x 180	50	0,05	5,60
63264	teleskopik / telescopic	500 x 500 x 180	55	0,06	5,90
63265	teleskopik / telescopic	550 x 500 x 180	60	0,06	6,20
63285	frenli / soft close	300 x 500 x 180	35	0,04	4,70
63286	frenli / soft close	350 x 500 x 180	40	0,04	5,00
63287	frenli / soft close	400 x 500 x 180	45	0,04	5,30
63288	frenli / soft close	450 x 500 x 180	50	0,05	5,60
63289	frenli / soft close	500 x 500 x 180	55	0,06	5,90
63290	frenli / soft close	550 x 500 x 180	60	0,06	6,20

Tandem raylı çekmece grubu / Tandem slides drawer group

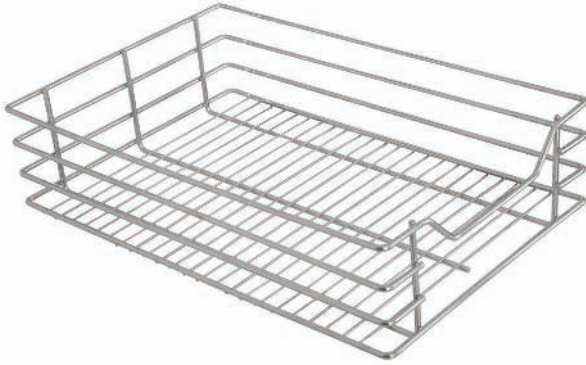

- Tezgah altında, menteşeli kapaklı dolaplarda ya da modül kapağına monte edilerek kullanılır.
- Taşıma kapasitesi 15 kg dır.
- Standart, tek açılım ya da çift açılım tandem raylarla kullanılabilir.
- 6 farklı modül genişliğine uygun sepetler krom kaplamalıdır.

- Available under-counter hinged cabinets with door or mounted module covers.
- Carrying capacity 15 kg.
- Can be used with standart, single-extension soft close or full-extension soft close tandem rails.
- Baskets with 6 different module sizes are chrome plated.

Tandem raylı çekmece grubu / Tandem drawer group

Ürün Kodu / Product Code	Tip / Type	Ölçüler / Size GxDxY / WxDxH (mm)	Modül / Modul (mm)	Hacim / Volume (m3)	Ağırlık / Weight (kg)
64403	çift aç.frenli / full extension.soft close	300 x 500 x 150	35	0,04	5,00
64404	çift aç.frenli / full extension.soft close	350 x 500 x 150	40	0,04	5,30
64405	çift aç.frenli / full extension.soft close	400 x 500 x 150	45	0,04	5,60
64406	çift aç.frenli / full extension.soft close	450 x 500 x 150	50	0,05	5,90
64407	çift aç.frenli / full extension.soft close	500 x 500 x 150	55	0,06	6,20
64408	çift aç.frenli / full extension.soft close	550 x 500 x 150	60	0,06	6,50
64423	tek aç.frenli / single extension.soft close	300 x 500 x 150	35	0,04	5,00
64424	tek aç.frenli / single extension.soft close	350 x 500 x 150	40	0,04	5,30
64425	tek aç.frenli / single extension.soft close	400 x 500 x 150	45	0,04	5,60
64426	tek aç.frenli / single extension.soft close	450 x 500 x 150	50	0,05	5,90
64427	tek aç.frenli / single extension.soft close	500 x 500 x 150	55	0,06	6,20
64428	tek aç.frenli / single extension.soft close	550 x 500 x 150	60	0,06	6,50

Eviye altı çekmece grubu / Sink drawer group



- Tezgah altında, menteşeli kapaklı dolaplarda ya da modül kapağına monte edilerek kullanılır.
- Taşıma kapasitesi 15 kg dır.
- Standart, tek açılım ya da çift açılım tandem raylarla kullanılabilir.
- 2 farklı modül genişliğine uygun sepetler krom kaplamalıdır.

- Available under-counter hinged cabinets with door or mounted module covers.
- Carrying capacity 15 kg.
- Can be used with standart, single-extension soft close or full-extension soft close tandem rails.
- Baskets with 2 different module sizes are chrome plated.

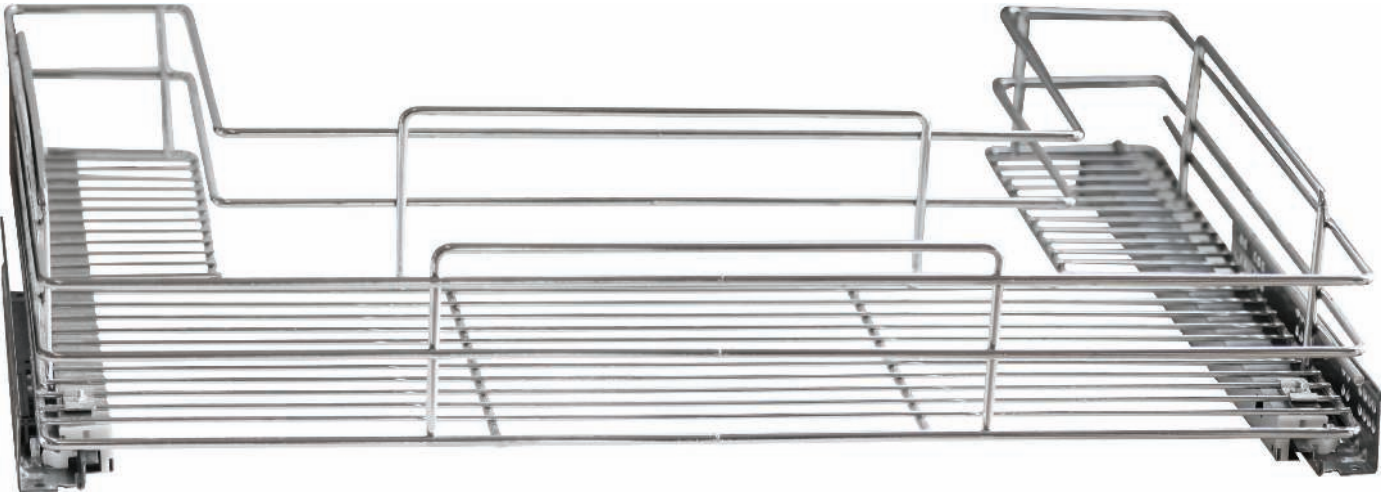

Tandem raylı eviye altı çekmece / Tandem sink drawer

Ürün Kodu / Product Code	Tip / Type	Ölçüler / Size GxDxY / WxDxH (mm)	Modül / Modul (mm)	Hacim / Volume (m3)	Ağırlık / Weight (kg)
61001	Çift açılım frenli / full extension soft close	764 x 500 x 110	80	0,10	5,00
61005	Çift açılım frenli / full extension soft close	864 x 500 x 110	90	0,12	6,00

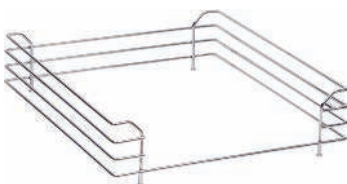

KOD: 68205

Çekmece çerçevesi / Drawer frame

Ürün Kodu / Product Code	Ölçüler / Size GxDxY / WxDxH (mm)	Modül / Modul (mm)	Hacim / Volume (m3)	Ağırlık / Weight (kg)
68203	280 x 500 x 120	35	0,01	1,20
68204	330 x 500 x 120	40	0,01	1,40
68205	380 x 500 x 120	45	0,01	1,60
68206	430 x 500 x 120	50	0,02	1,80
68207	480 x 500 x 120	55	0,02	2,00

Mutfak aksesuarları grubu / Kitchen accessories group



- Tezgahüstü grubundaki ürünlerin montajında kullanılırlar.
- Borular tapalı ve krom kaplamadır.

- Used for the assembly of over-counter units.
- Pipes have caps and are chrome plated.

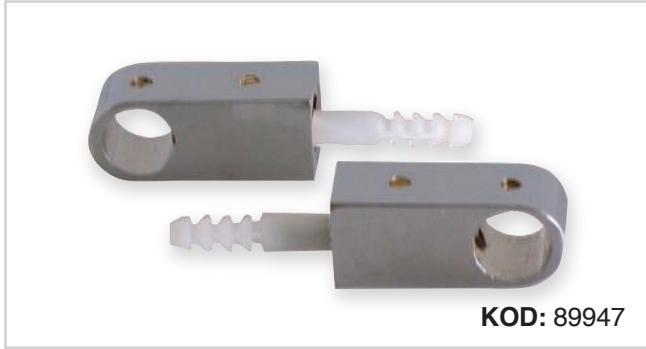

KOD: 89947



KOD: 89948



KOD: 89949



KOD: 88910

Set arası askı grubu / Midway set hang group

Ürün Kodu / Product Code	Ürün Adı / Product Name	Koli içi ad. / In box	Hacim / Volume (m3)	Ağırlık / Weight (kg)
89149	tapalı boru 40 cm / pipe with tube plug 40 cm	10	0,01	0,15
89150	tapalı boru 50 cm / pipe with tube plug 50 cm	10	0,01	0,19
89151	tapalı boru 60 cm / pipe with tube plug 60 cm	10	0,01	0,22
89152	tapalı boru 80 cm / pipe with tube plug 80 cm	10	0,01	0,29
89153	tapalı boru 100 cm / pipe with tube plug 100 cm	10	0,01	0,36
89154	tapalı boru 120 cm / pipe with tube plug 120 cm	10	0,01	0,44
88910	50 cm boru bağlantı kanca set / 50 cm pipe connector hook set		0,01	0,36
89947	bağlantı takım / connector set		0,01	0,01
89948	tekli kanca / single hook		0,01	0,01
89949	ikili kanca / double hook		0,01	0,01



KOD: 88801



KOD: 88802



KOD: 88803

- Ürünler krom kaplamadır.
- Plastik tapalar mevcuttur.
- Set olan ürünlerimize boru ve bağlantılar dahildir.

- Products are chrome plated.
- Plastic caps are available.
- Pipe and connectors are included in sets.



KOD: 80801



KOD: 88802



KOD: 88803

Havluluk - folyoluk / Towel - foil paper

Ürün Kodu / Product Code	Tip / Type	Ölçüler / Size GxDxY / WxDxH (mm)	Koli içi ad. / In box	Hacim / Volume (m3)	Ağırlık / Weight (kg)
80801	üçlü / triple	320 x 150 x 370	10	0,22	1,50
80802	ikili / double	320 x 150 x 300	10	0,22	1,30
80803	tekli / single	320 x 150 x 260	10	0,22	1,20
88801	üçlü / triple (SET)	320 x 150 x 370	8	0,22	2,00
88802	ikili / double (SET)	320 x 150 x 300	8	0,22	1,80
88803	tekli / single (SET)	320 x 150 x 260	8	0,22	1,70



KOD: 88804



KOD: 88808



KOD: 88809

- Ürünler krom kaplamadır.
- Plastik tapalar mevcuttur.
- Set olan ürünlerimize boru ve bağlantılar dahildir.

- Products are chrome plated.
- Plastic caps are available.
- Pipe and connectors are included in sets.



KOD: 81804

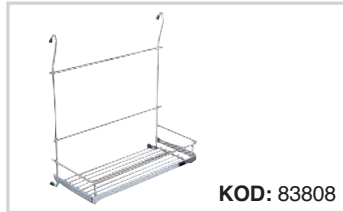

KOD: 83808



KOD: 83809

Baharatlık / Spice holder

Ürün Kodu / Product Code	Tip / Type	Ölçüler / Size GxDxY / WxDxH (mm)	Koli içi ad. / In box	Hacim / Volume (m3)	Ağırlık / Weight (kg)
81804	klasik / classic	320 x 170 x 330	10	0,22	1,50
83808	uzun / long	325 x 170 x 370	10	0,22	1,30
83809	kısa / short	330 x 170 x 290	10	0,22	1,20
88804	klasik / classic (SET)	320 x 170 x 330	8	0,22	2,00
88808	uzun / long (SET)	325 x 170 x 370	8	0,22	1,80
88809	kısa / short (SET)	330 x 170 x 290	8	0,22	1,70



KOD: 88001

- 3lü havluluk, klasik baharatlık, 80cm boru, 5 adet kanca ve bağlantılı elamanlarından oluşan bir settir.
- Tüm ürünler krom kaplamadır.
- Plastik tapalar mevcuttur.

- This set includes a triple towel rack, a spice holder, a 80cm pipe, 5 hooks and connectors.
- All products in this set are chrome plated.
- Plastic caps are available.



KOD: 88001

Askılı ürünler / Hanged products

Ürün Kodu / Product Code	Tip / Type	Ölçüler / Size GxDxY / WxDxH (mm)	Koli içi ad. / In box	Hacim / Volume (m3)	Ağırlık / Weight (kg)
88001	Set 1 / Set 1	750 x 185 x 375	4	0,20	4,60



- Yıkamış bulaşıklarınızı organize etmekte yardımcı olur.
- Plastik tepsi ve kaşıklik mevcuttur.
- Tüm ürünler krom kaplamadır.

- Helps to organize your washed dishes.
- Plastic plate and spoon holder are available
- All products are chrome plated.



KOD: 86074



KOD: 86073



KOD: 86072

Tabaklık grubu / Dish holder

Ürün Kodu / Product Code	Tip / Type	Ölçüler / Size GxDxY / WxDxH (mm)	Koli içi ad. / In box	Hacim / Volume (m3)	Ağırlık / Weight (kg)
86074	tekli krom tabaklık / dish holder single	360 x 440 x 130	6	0,22	1,85
86073	iki katlı krom tabaklık / dish holder double	360 x 440 x 240	4	0,22	2,70
86072	uzun krom tabaklık / dish holder long	370 x 785 x 250	4	0,22	3,35

Dolap içi tabaklık-bardaklık / Plate -glass shelf

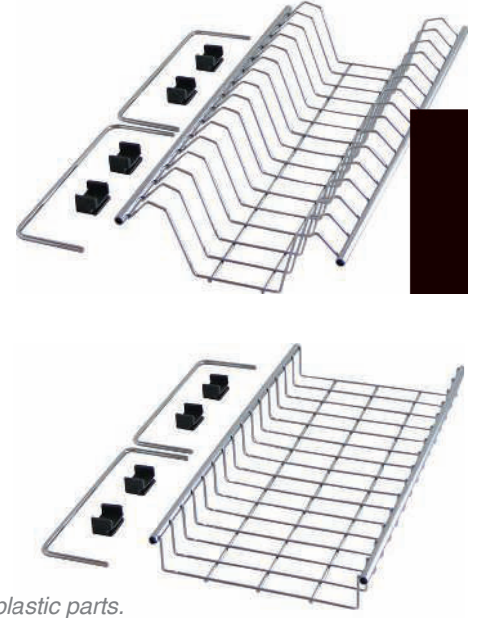

- Plastik aparatlarla dolap yanlarına bağlanır. • Fixed to the sides of the cabinet with plastic parts.
- Sabit ya da ayarlanabilir özelliklidir. • Can be fixed or adjustable.
- Sepetler krom kaplamadır. • Baskets are chrome plated.

Ayarlanabilir tabaklık-bardaklık / Adjustable plate-glass holder

Ürün Kodu / Product Code	Tip / Type	Modül / Modul	Ölçüler / Size GxDxY / WxDxH (mm)	Koli içi ad. / In box	Hacim / Volume (m3)	Ağırlık / Weight (kg)
45010	tabaklık / dish holder	55-60	500 x 250 x 80	10	0,07	0,85
45011	tabaklık / dish holder	65-70	600 x 250 x 80	10	0,09	1,00
45012	tabaklık / dish holder	75-80	700 x 250 x 80	10	0,09	1,15
45013	tabaklık / dish holder	85-90	800 x 250 x 80	10	0,12	1,30
45014	tabaklık / dish holder	95-100	900 x 250 x 80	10	0,12	1,45
40010	bardaklık / glass holder	55-60	500 x 250 x 80	10	0,07	0,80
40011	bardaklık / glass holder	65-70	600 x 250 x 80	10	0,09	0,95
40012	bardaklık / glass holder	75-80	700 x 250 x 80	10	0,09	1,10
40013	bardaklık / glass holder	85-90	800 x 250 x 80	10	0,12	1,25
40014	bardaklık / glass holder	95-100	900 x 250 x 80	10	0,12	1,40



Damlalıklı tabaklık-bardaklık / Dish&bottle with dropper

Ürün Kodu / Product Code	Tip / Type	Modül / Modul	Ölçüler / Size GxDxY / WxDxH (mm)	Koli içi ad. / In box	Hacim / Volume (m3)	Ağırlık / Weight (kg)
40141	bardaklık / glass holder	60	564 x 250 x 80	10	0,07	1,00
45141	tabaklık / dish holder	60	564 x 250 x 80	10	0,09	1,15
40143	bardaklık / glass holder	80	764 x 250 x 80	10	0,09	1,30
45143	tabaklık / dish holder	80	764 x 250 x 80	10	0,12	1,45
42141	tabaklık-bardaklık (SET) / dish and glass holder (SET)	60	564 x 250 x 80	1	0,02	2,15
44141	tabaklık-bardaklık (SET) / dish and glass holder (SET)	80	764 x 250 x 80	1	0,02	2,75



- Mutfaklarınıza ya da salonlarınıza dekoratif çözüm sunar.
- 4 farklı boru seçeneğiyle istediğiniz yerde kullanabilirsiniz.
- 5 farklı sepet seçeneği mevcuttur.
- Metal flanşlar dahildir.
- Sepetler, boru ve metal flanşlar krom kaplamadır.

- Provides decorative solutions to your kitchens or living rooms.
- 4 different pipe lengths are available.
- 5 different baskets are available.
- Metal flanges are included.
- Baskets, pipes and metal flanges are chrome plated

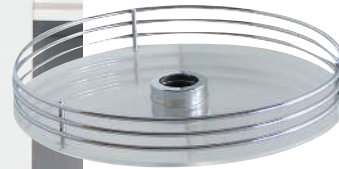

KOD: 53310



KOD: 53318



KOD: 53312



KOD: 53320



KOD: 53316



KOD: 533344

KOD: 53344



boru ile birlikte verilir. comes with the pipe.

Bar grubu / Bar group

Ürün Kodu / Product Code	Tip / Type	Ölçüler / Size GxDxY / WxDxH (mm)	Koli içi ad. / In box	Hacim / Volume (m3)	Ağırlık / Weight (kg)
53302	barborusu / bar pipe	1000 x (Ø) 42,5	1	0,01	4,30
53304	barborusu / bar pipe	1300 x (Ø) 42,5	1	0,01	4,60
53305	barborusu / bar pipe	1500 x (Ø) 42,5	1	0,02	5,00
53306	barborusu / bar pipe	2100 x (Ø) 42,5	1	0,02	5,40
53344	duvar bağlantısı / wall connector		5	0,08	0,80
53310	pleksi taban / plexy round	90x (Ø) 365	5	0,08	2,10
53312	ağşap taban / wooden round	70x (Ø) 365	5	0,08	2,10
53316	hasır döner taban / wire round	55x (Ø) 365	5	0,08	1,40
53318	hasır üçgen taban / wire triangle round	55x (Ø) 365	5	0,08	1,20
53320	kadehlik / drinking glass holder	70x (Ø) 365	5	0,08	1,30

Bar grubu / Bar group



KOD: 53450

Bar grubu / Bar group

Ürün Kodu / Product Code	Tip / Type	Ölçüler / Size GxDxY / WxDxH (mm)	Koli içi ad. / In box	Hacim / Volume (m3)	Ağırlık / Weight (kg)
53450	bar standı / bar stand	720 x 350 x 350	1	0,07	5,40

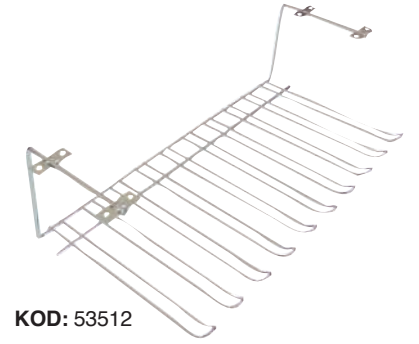

KOD: 53512

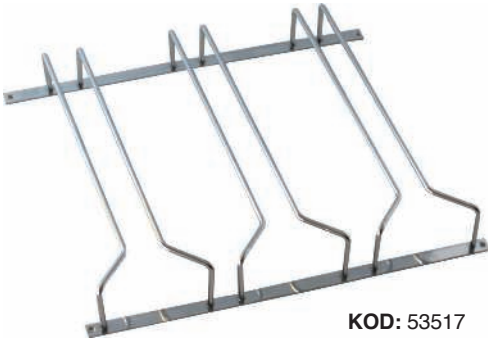

KOD: 53517



KOD: 53516



KOD: 53515

Bar grubu / Bar group

Ürün Kodu / Product Code	Tip / Type	Ölçüler / Size GxDxY / WxDxH (mm)	Koli içi ad. / In box	Hacim / Volume (m3)	Ağırlık / Weight (kg)
53515	lamalı kadehlik tekli / single sheet	225 x 357 x 60	30	0,12	0,25
53516	lamalı kadehlik ikili / double sheet	265 x 357 x 60	20	0,12	0,55
53517	lamalı kadehlik üçlü / triple sheet	395 x 357 x 60	10	0,12	0,85
53512	sabit kadehlik / fixed sheet	460 x 240 x 150	20	0,12	0,90

Gardrop grubu / Wardrop group



Pantolon askısı grubu / Panth holder

Yandan bağlantılı pantolon askısı grubu
Side Tied Tis Panth Holder

Modül / Modul	Ölçüler / Size GxDxY / WxDxH (mm)	Koli içi ad. / In box	Hacim / Volume (m3)	Ürün Kodu / Product Code	Ağırlık / Weight (kg)
30-35	260 x 500 x 30	5	0,03	75116	1,95
35-40	310 x 500 x 30	5	0,04	75117	2,05
40-45	360 x 500 x 30	5	0,04	75118	2,15
45-50	410 x 500 x 30	5	0,05	75119	2,25
50-55	460 x 500 x 30	5	0,05	75120	2,35
55-60	510 x 500 x 30	5	0,07	75121	2,45
60-65	560 x 500 x 30	5	0,07	75122	2,55
65-70	610 x 500 x 30	5	0,07	75123	2,65
70-75	660 x 500 x 30	5	0,09	75124	2,75
75-80	710 x 500 x 30	5	0,09	75125	2,85
80-85	760 x 500 x 30	5	0,09	75126	2,95
85-90	810 x 500 x 30	5	0,10	75127	3,05
90-95	860 x 500 x 30	5	0,10	75128	3,15
95-100	910 x 500 x 30	5	0,10	75129	3,25
100-105	960 x 500 x 30	5	0,10	75130	3,35

Banyo aksesuarları grubu / Bath accessories



Askılı çamaşır sepeti / Hooked laundry basket

Ürün Kodu / Product Code	Modül / Modul	Ölçüler / Size GxDxY / WxDxH (mm)	Koli içi ad. / In box	Hacim / Volume (m3)	Ağırlık / Weight (kg)
79377	300	230 x 315 x 500	4	0,177	2,45
79378	350	280 x 315 x 500	4	0,212	2,85
79379	400	330 x 315 x 500	4	0,247	3,10
79380	450	380 x 315 x 500	4	0,281	3,35
79381	500	430 x 315 x 500	4	0,316	3,65
79382	550	480 x 315 x 500	4	0,342	3,75
79383	600	530 x 315 x 500	4	0,368	3,85

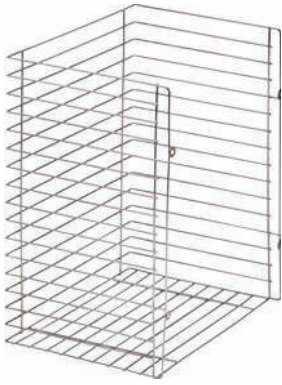

Kapağa monte çamaşır sepeti / Laundry basket

Ürün Kodu / Product Code	Tip / Type	Modül / Modul	Ölçüler / Size GxDxY / WxDxH (mm)	Koli içi ad. / In box	Hacim / Volume (m3)	Ağırlık / Weight (kg)
79080		300	230 x 250 x 500	8	0,12	0,80
79081		350	280 x 250 x 500	8	0,12	0,90
79082		400	330 x 250 x 500	8	0,12	1,30
79083		450	380 x 250 x 500	8	0,12	1,50
79084		500	430 x 250 x 500	8	0,12	1,50
79085		550	480 x 250 x 500	8	0,15	1,70
79086		600	530 x 250 x 500	8	0,15	1,90
79087		650	580 x 250 x 500	8	0,15	2,10



Banyo köşe / Bath corner

Ürün Kodu / Product Code	Tip / Type	Ölçüler / Size GxDxY / WxDxH (mm)	Koli içi ad. / In box	Hacim / Volume (m3)	Ağırlık / Weight (kg)
79410	ikili / single	310 x 230 x 315	20	0,22	1,10
79412	üçle / triple	310 x 230 x 525	16	0,22	1,40

Sertifikalarımız / Our Certifications



СИСТЕМА СЕРТИФИКАЦИИ ГОСТ Р
ФЕДЕРАЛЬНОЕ АГЕНТСТВО ПО ТЕХНИЧЕСКОМУ РЕГУЛИРОВАНИЮ И МЕТРОЛОГИИ

СЕРТИФИКАТ СООТВЕТСТВИЯ

№ РОСС TR.ДЕ01.Н38643
Срок действия с 24.06.2013г. по 23.06.2016г.
№ 0651535

ОРГАН ПО СЕРТИФИКАЦИИ
РОСС DE.0001.11.ДЕ01
ДИН ГОСТ ТЮФ БЕРЛИН-БРАНДЕНБУРГ Общество по сертификации в Европе,
Будапештер Штр. 31, 10787 Берлин, Германия, Тел: +49/302601 2110, Факс: +49/302601 1210, service@din-gost.de

ПРОДУКЦИЯ
изделия кухонные и ванные из черных металлов (Сталь или Алюминий), хромированные: полочки, стеллажи, сетки, держатели, полки-карусели, бутылочницы, корзины, крючки, подставки, вешалки
серийный выпуск
СООТВЕТСТВУЕТ ТРЕБОВАНИЯМ НОРМАТИВНОГО ДОКУМЕНТА
ГОСТ Р 51687-2000, код ОК 005 (ОКП): 14 8000

ИЗГОТОВИТЕЛЬ
DOMODEK NURETTİN SEVGÜN
KOSBY ANKARA ASFALTI 26.KM KEMALPAŞA

СЕРТИФИКАТ ВЫДАН
DOMODEK NURETTİN SEVGÜN
KOSBY ANKARA ASFALTI 26.KM KEMALPAŞA

НА ОСНОВАНИИ
сертификата № 0110-13 от 19.06.2013 г., выданного

МІНІСТЕРСТВО ОХОРОНИ ЗДОРОВ'Я УКРАЇНИ
ДЕРЖАВНА САНИТАРНО-ЕПІДЕМІОЛОГІЧНА СЛУЖБА

ЗАТВЕРДЖУЮ

Міністерство охорони здоров'я України
(назва установи)
вул.Грушевського, 7, м.Київ, 01601
(місцезнаходження)
253-94-84, 559-29-88

Перший заступник головної державно-санітарної інспекції України
О.П. Кравчук

к державної санітарно-епідеміологічної експертизи

24. 2013р. № 05.03.02-03/ 62298

тки, тримачі, полиці-каруселі, бутылочниця, корзини, гачки, релінги, тримачі, сталі, алюміній хромовані)
(об'єкт експертизи)

(код за ДСТН, код за УК СТБ і етикетки)

кухонь, ванні, оптово-роздрібна торгівля
(сфери застосування та реліації об'єкта експертизи)

TIN SEVGİN*, Туреччина, KOSBI ANKARA ASFALTI 26.KM KEMALPAŞA / İZMİR
(оригінал виробника, адреса, місцезнаходження, телефон, факс, E-mail, WWW)

TIN SEVGİN*, Туреччина, KOSBI ANKARA ASFALTI 26.KM KEMALPAŞA / İZMİR
(завдання експертизи, адреса, місцезнаходження, телефон, факс, E-mail, WWW)

до документів, що супроводжують вантаж
(назва протоколу на останньому об'єкті експертизи в Україні)

відповідає встановленим медичним критеріям безпеки / показникам: стання не чинить шкідливого впливу на здоров'я людей.
(критерії безпеки / показники)

при використанні / застосуванні, зберіганні, транспортуванні, утилізації, знищення
виробленої продукції необхідно дотримуватись вимог даного висновку, чинного (санітарних норм та правил, особливості умов використання, застосування, зберігання, транспортування, утилізації, знищення)

даного санітарно-епідеміологічної експертизи Полочки, стелажі, сітки, тримачі, полиці, корзини, гачки, релінги, тримачі, підставки, вешалки (сталь, алюміній хромовані), за відомою відповідно вимогам діючого санітарного законодавства України і за умови його висновку може бути використаний в зазначеній сфері застосування.

згідно рекомендацій виробника.
не, використання згідно з інструкцією виробника. Висновок не може бути використаний як якостей виробу або продукції.
(інформація щодо етикетки, інструкції, правила тощо)

з 12 липня 2015 р.

підписання вимог цього висновку несе заявник.
технології виготовлення, які можуть змінити властивості об'єкта експертизи або її вплив на здоров'я людей, сфери застосування, умов застосування об'єкта експертизи

TSEK TÜRK STANDARDLARI ENSTİTÜSÜ
KRİTERE UYGUNLUK BELGESİ
TURKISH STANDARDS INSTITUTION
CERTIFICATE OF CONFORMANCE TO CRITERIA

Markanın Tanımı	Description of the Mark
TSEK veya / TSEK	
BELGE NUMARASI REFERENCE NUMBER OF LICENCE	079514-TSEK-01/01
BELGENİN İLK VERİLİŞ TARİHİ DATE OF FIRST ISSUE OF LICENCE	27.05.2008
BELGENİN SON GEÇERLİLİK TARİHİ LICENCE VALID UNTIL	27.05.2019
BELGE SAHİBİ KURULUŞUN ADI NAME OF THE LICENCE HOLDER	DOMODEK METAL PLASTİK MAKİNA SAN. VE TİC.LTD. ŞTİ
BELGE SAHİBİ KURULUŞUN ADRESİ ADDRESS OF THE LICENCE HOLDER	ANSIZCA SANAYİ SİTESİ SOKAK NO : 346/A ORGANİZE SANAYİ BÖLGESİ KEMALPAŞA - İZMİR İZMİR
ÜRETİM YERİ ADI NAME OF THE MANUFACTURING PLACE	DOMODEK METAL PLASTİK MAKİNA SAN. VE TİC.LTD. ŞTİ
ÜRETİM YERİ ADRESİ ADDRESS OF THE MANUFACTURING PLACE	ANSIZCA SANAYİ SİTESİ SOKAK NO : 346/A ORGANİZE SANAYİ BÖLGESİ KEMALPAŞA - İZMİR İZMİR
TESCİLLİ TİCARİ MARKASI REGISTERED TRADE MARK	DOMODEK
İLGİLİ BELGELENDİRME KRİTERİ RELATED TURKISH STANDARD	OBM-00-BK-000 / Kriteri Seçilmemiş Sözleşmeler için / 24.08.2010
BELGE KAPSAMI SCOPE OF LICENCE	MUTFAK DOLAP İÇİ RAF (KİLER) SİSTEMLERİ VE AKSESUARLARI DOLAP İÇİ VEYA ASMA SİSTEMLİ KROM KAPLI.

2016
AHMET NAMLI
İZMİR BELGELENDİRME MÜDÜRÜ

*Bu belge, belgelendirilen ürünün üretim sürecini düzenleyen belgelendirme şartları çerçevesinde geçerlidir.
*This certificate is valid for the production process of the product within the scope of the certification conditions.
*TSE ÇİFT BELGELENDİRME MÜDÜRLÜĞÜ Adres: Etiler Mah. Nispetiye Sok. Kat: 11/11 Beşiktaş / İstanbul - Tel: 0212 448 42 30 * Web: www.tse.org.tr
*TSE BELGELENDİRME MERKEZİ BAŞKANLIĞI Adres: Nispetiye Mah. Nispetiye Sok. Kat: 11/11 Beşiktaş / İstanbul - Tel: 0212 448 42 30 * Web: www.tse.org.tr

Notlar / Notes

- Baskıda oluşacak tipografik hatalardan firmamız sorumlu tutulamaz.
- Hammade ile ilgili maliyet artışları fiyatlara yansıtılacaktır.
- Bu katalog içeriği ve görselleri, izin alınmaksızın çoğaltılamaz ve başka yerde kullanılamaz.

"Firmamız ürün tasarımlarında ve görsellerinde değişiklik yapma hakkını saklı tutar. Sevk edilen ürünlerde katalogdaki referans resimler değil, güncel tasarımlar göz önünde bulundurulur."

DOMODEK®

İZMİR

Metal mutfak aksesuarları kiler, banyo, gardrop ve bar sistemleri
Metal kitchen accessories pantry, bathroom, wardrop and bar systems

Fabrika (Factory):

Adres (Address): Kemalpaşa O.S.B. Ansızca San. Sit. Sk. No: 346/A 35170 Kemalpaşa
İZMİR TURKEY

Tel: +90 232 878 00 15 – Fax: +90 232 878 61 74

Web: www.domodek.com

E-mail: bilgi@domodek.com



0536 353 02 02



Made in Turkey

TSEK

